



გაკურ სულაკაურის
გამომცემლობა

NEW BUILDING BLOCKS

3

მოსწავლის წიგნი გაყოფილია ორ ნაწილად. მეორე ნაწილი დანომრილია ორგვარად. სარჩევში გვერდები მითითებულია პირველი, მსხვილი შრიფტით მოცემული ნუმერაციის მიხედვით. მეორე, მკრთალი და პატარა შრიფტით დაბეჭდილი ნუმერაცია გულისხმობს პირველი წიგნის გაგრძელებას, რაც დატოვებულია სპეციალურად. ეს მასწავლებელს გაუადვილებს, იოლად იპოვოს ის გვერდი, რომლის ნომერიც ზოგიერთ შემთხვევაში მასწავლებლის წიგნშია მითითებული (სავარჯიშოების პასუხები, კონკრეტული სავარჯიშოს ან დავალების მითითება და ა.შ.).

New Building Blocks 3

ინგლისურის სახელმძღვანელო მესამეკლასელთათვის (ნაწილი I)

მოსწავლის რეჟული

თბილისი, 2018

ადაპტაციის ავტორი **თამარ ჯაფარიძე**
ყდის დიზაინერი ია **მახათაძე**
ტექნიკური დიზაინერი **ლადო ლომსაძე**

ადაპტაცია © ბაკურ სულაკაურის გამომცემლობა, 2018
ყველა უფლება დაცულია

შპს „ბაკურ სულაკაურის გამომცემლობა“
მისამართი: დავით აღმაშენებლის 150, თბილისი 0112
ტელ.: 291 09 54, 291 11 65
ელფოსტა: info@sulakauri.ge

ISBN 978-9941-30-066-0

all rights reserved.
www.sulakauri.ge

New Building Blocks 3

Workbook (Part 1)

Profil Klett

Zagreb, Hrvatska, 2014.

© Profil Klett, 2014

გრიფინიჭებულია საქართველოს განათლებისა და მეცნიერების სამინისტროს მიერ 2018 წელს.

NEW
BUILDING
BLOCKS



Workbook Answers



გაკურს სულაკაურის
გამომცემლობა

CONTENTS

LET'S START!

Welcome back! 6

UNIT 1 PETS

LESSON 1 UNCLE PHIL'S PET SHOP 8

LESSON 2 AT THE PET SHOW 10

LESSON 3 RONNIE'S TEA PARTY 12

LESSON 4 A SPECIAL PET 14

LESSON 5 LET'S CHECK! 16

UNIT 2 THE WEEKEND

LESSON 1 THE MISSING BABY TIGER 18

LESSON 2 WHAT'S UP? 20

LESSON 3 SUPER SUZY 22

LESSON 4 KIM'S SONG 24

LESSON 5 LET'S CHECK! 26

UNIT 3 SUMMER ADVENTURES

Lesson 1 A Summer Pinboard 28

Lesson 2 Uncle Phil's Trip 30

Lesson 3 Pixy's New Coat 32

Lesson 4 The Summer Rap 36

Lesson 5 Let's Check! 38

UNIT 4 A NEW SCHOOL YEAR

Lesson 1 A New Classroom 40

Lesson 2 Maths Riddles 44

Lesson 3 Meet Ms Springfield 48

Lesson 4 One, Two, ... 50

Lesson 5 Let's Check! 52

UNIT 5 THE WEEK, DAYS, HOURS

Lesson 1 What Can Robbie Do? 6

Lesson 2 A Busy Week 10

Lesson 3 Super Suzy Is Back! 14

Lesson 4 A Silly Week 16

Lesson 5 Let's Check! 18

UNIT 6 THE CALENDAR

Lesson 1 Guess the Months! 20

Lesson 2 What's Your Favourite Season? 24

Lesson 3 The Fox and the Hedgehog 28

Lesson 4 Itsy Bitsy Spider 32

Lesson 5 Let's Check! 34

UNIT 7 HOME SWEET HOME

Lesson 1 Elliot's House 36

Lesson 2 Where Is Gizmo? 38

Lesson 3 Home Sweet Home 42

Lesson 4 A Magic Mess 44

Lesson 5 Let's Check! 46

THE FINAL RACE

Lesson 1 Robbie's Friend 48

Lesson 2 The Building Blocks Jeopardy 50

Lesson 3 The Building Blocks Farewell Party 52

APPENDIX

The Halloween Song 56

Letters to Santa Claus 58

Counting Valentines 61

Ronnie's Egg Hunt 62

PICTURE SYMBOLS



LISTEN



COLOUR



SPEAK



POINT



SING



CIRCLE



READ



TICK



WRITE



MATCH



CUT OUT



CROSS OUT



TRACE



FIND



DRAW



STICK

WELCOME BACK!

1 Who's talking? Match.



I've got a funny uncle.

3

I'm clever and funny. Bow-wow!

4

I like music. Sing with me!

5

I've got red hair.

2

I like English. And my dog, too!

1

2 Listen and circle the correct word.

1 Hi, I'm Jessica. Kim

2 I'm 5. 9

3 I've got a dog a cat.



4 His name is Ronnie. Gizmo

5 I'm happy hungry today.

6 Gizmo is happy hungry, too.

3 Complete the sentences.

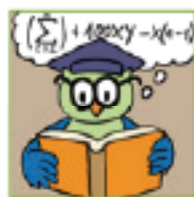

clever

sister

10

owl

black

magic

1 Hi, I'm Elliot. I'm 10.

2 I like books and magic.



3 I've got a pet owl. Her name is Tess.

4 She is very clever.

5 I've got a sister. Her name is April.

6 She has got a pet, too. It's a big black spider. His name is Buggy. Yuck!

4 Now listen and check.

5   Chi wants to learn English with the BB Club. Ronnie has got a lot of questions for her! Listen and match.

- | | |
|-------------------------------|----------------------------------|
| 1 What's your name? | 7 I'm very happy. |
| 2 How old are you? | 5 My best friend is Li. |
| 3 Is your family very big? | 3 No, only my mum and me. |
| 4 Have you got a pet? | 2 I'm 9. |
| 5 Who is your best friend? | 1 My name's Chi. |
| 6 What's your favourite book? | 8 Yes, very much! |
| 7 How are you today? | 4 Yes, a turtle. His name is Zu. |
| 8 Do you like English? | 6 It's <i>Pinocchio</i> . |



6  Answer Ronnie's questions. **Students' answers.**

- 1 What's your name?

- 2 How old are you?

- 3 Is your family very big?

- 4 Have you got a pet?

- 5 Who is your best friend?

- 6 What's your favourite book?

- 7 How are you today?

- 8 Do you like English?

WELCOME TO THE BB CLUB!



UNCLE PHIL'S PET SHOP

1 Find and circle. Then write and colour. **Students' answers.**



turtle



fox



dog



spider



parrot



fish



monkey

C	A	T	D	E	M	O	N	K	E	Y	C
F	S	N	A	K	E	S	P	I	D	E	R
O	T	U	R	T	L	E	K	X	O	Y	Z
X	G	O	L	D	F	I	S	H	G	A	V
N	U	P	A	R	R	O	T	Z	O	W	L



cat



owl



snake

2 Write.

under the table

in the cage

in the cupboard

on the shelf

on the chair

~~in the tank~~

under the chair

on the wall

under the table

1 Where is the fish? The fish is in the tank.

2 Where is the parrot? The parrot is in the cage.

3 Where is the fox? The fox is in the cupboard.

4 Where is the owl? The owl is on the shelf.

5 Where is the monkey? The monkey is on the chair.

6 Where is the spider? The spider is on the wall.

7 Where is the dog? The dog is under the table.

8 Where is the cat? The cat is under the chair.

9 Where is the snake? The snake is under the table.

3 Now listen and check.

4  Write: **in**, **on** or **under**.



1 The fox is under the table.



2 The cat is on the table.



3 The parrot is in the pocket.





4 The monkey is in the cupboard.

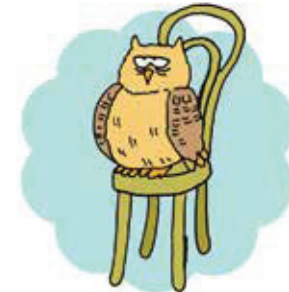

5 The snake is on the shelf.



6 The owl is on the chair.

5   Where is the turtle? Listen and draw.

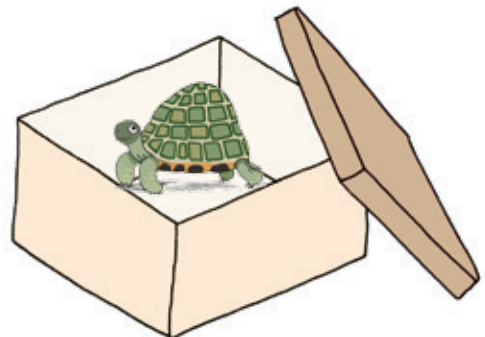
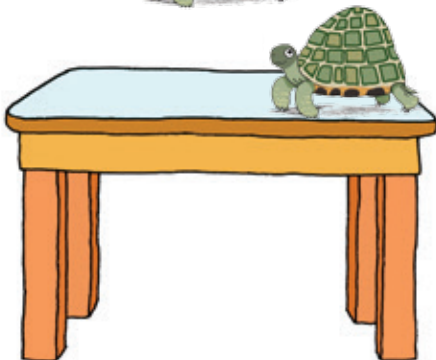
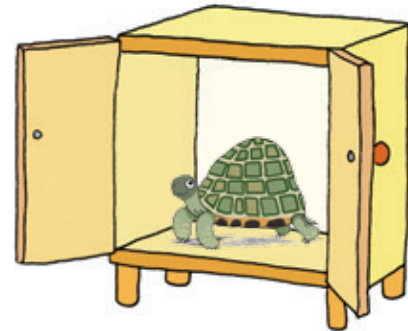
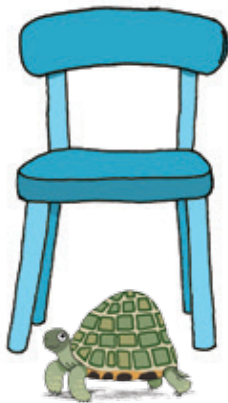

AT THE PET SHOW

1 Write.

1 Where are Ronnie and his friends?

 At the pet show.

2 What's the name of Miss Lemmon's cat?

 Poppy

3 Who has got a new turtle?

 Greg

4 What's the name of Elliot's owl?

 Tess

5 Who would like an ice cream?

 Ronnie

6 Who is the winner of the dog show?

 Gizmo



2 Do the crossword. What's the hidden word?

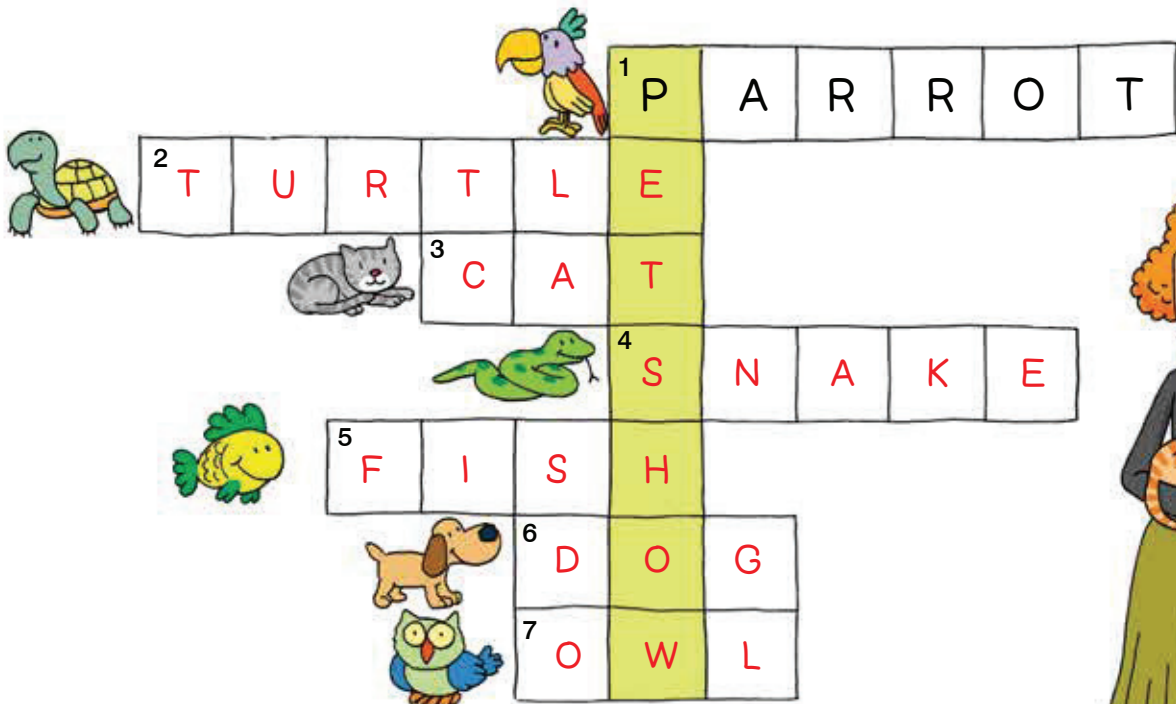

Hidden word: PET SHOP



3 Write.

Pet Magazine

Kim

GIZMO

clever eyes tail

bones dog

GIZMO - THE WINNER OF THE DOG SHOW

This is Gizmo. He is a dog. He has got small eyes and a short tail. He is small but very clever. He helps Kim get ready for school. He likes bones.

4 Listen and check.

5 Draw your pet and write about it. **Students' answers.**

Pet Magazine

This is _____.

It is a _____.

I love my pet. ❤️

RONNIE'S TEA PARTY

1  Match and write.



Gizmo	likes	carrot sandwiches.
Poppy		bones.
Marcus		milk.
Ronnie		bananas.

- 1 Gizmo likes bones.
- 2 Poppy likes milk.
- 3 Marcus likes bananas.
- 4 Ronnie likes carrot sandwiches.

2  Draw and speak. **Students' answers.**

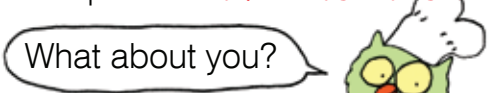

I like...

I don't like...



3 Write.

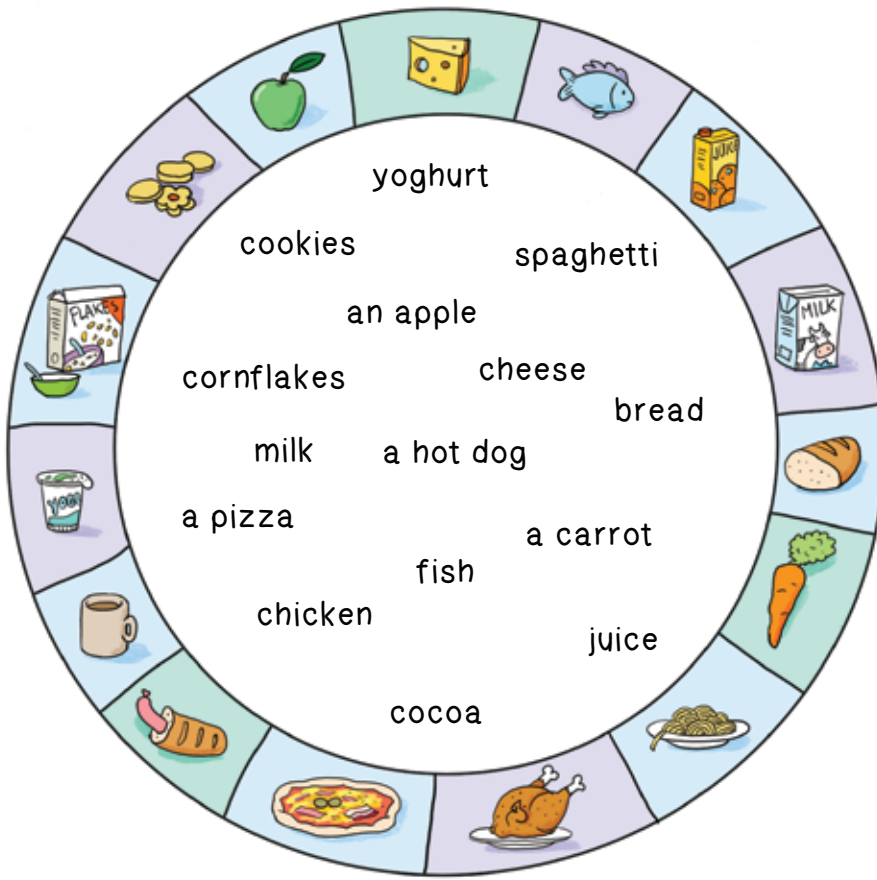

yoghurt,
cookies,
an apple, cornflakes,
milk, bread, cheese,
cocoa, juice

spaghetti,
bread,
a pizza, fish,
a carrot, chicken,
juice,

yoghurt,
spaghetti,
an apple, cheese, bread,
milk, fish, cocoa,
a hot dog, a pizza

4 Connect the numbers and colour the picture.
Students' answers.

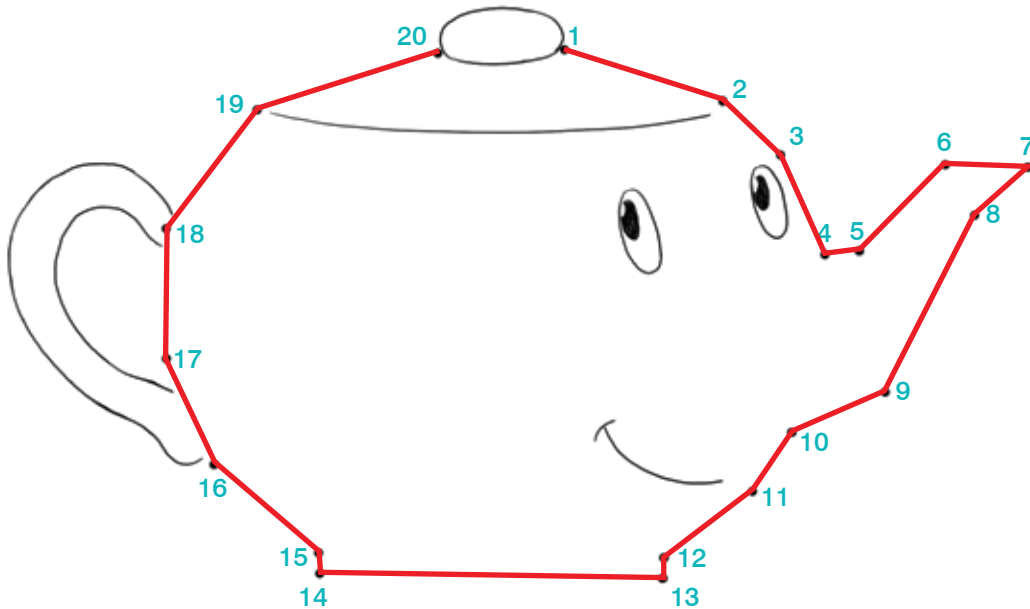

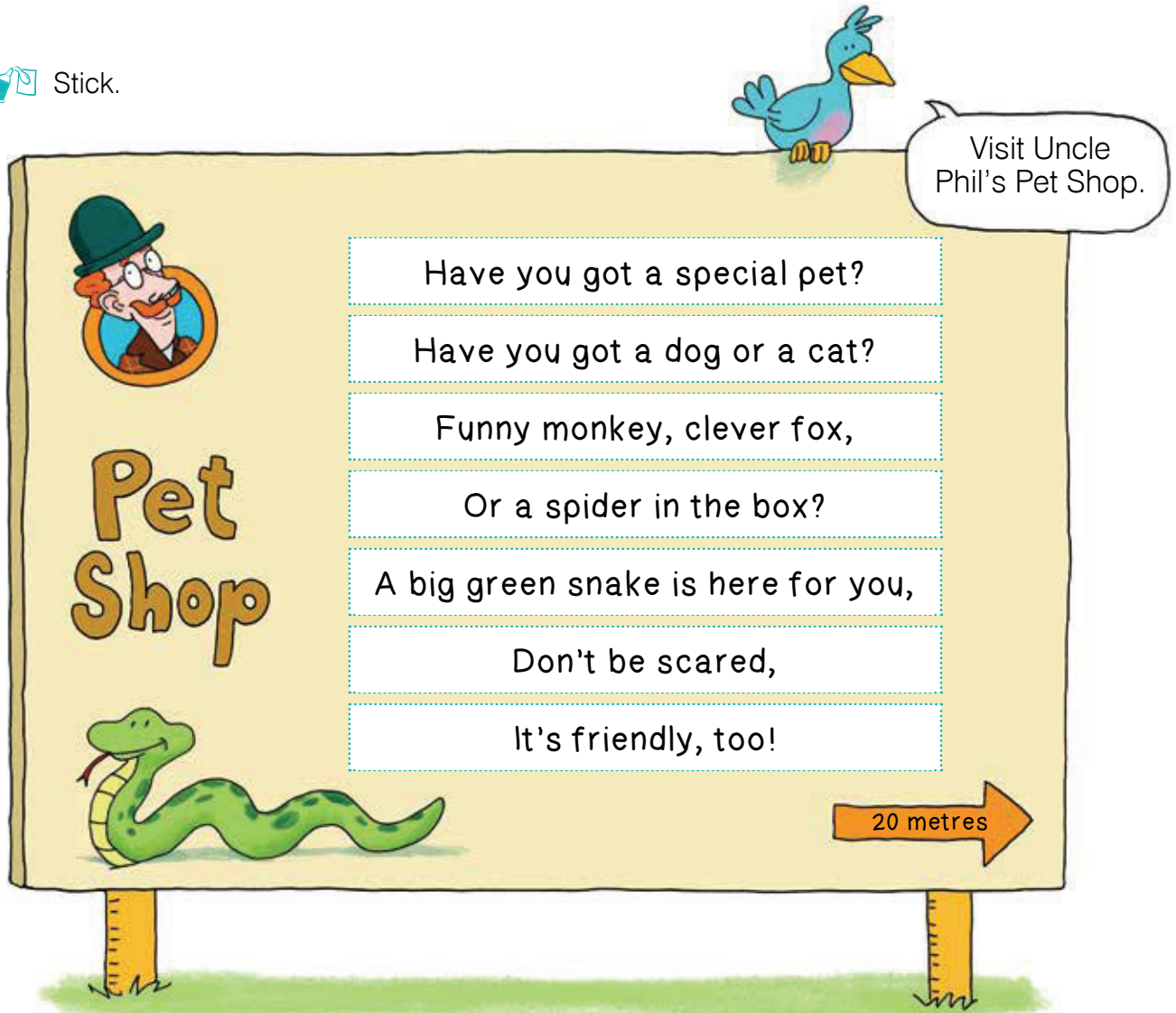

A SPECIAL PET

1  Stick.



2  Tick: YES or NO. **Students' answers.**

	YES	NO
1 Have you got a special pet?	<input type="checkbox"/>	<input type="checkbox"/>
2 Have you got a dog?	<input type="checkbox"/>	<input type="checkbox"/>
3 Have you got a cat?	<input type="checkbox"/>	<input type="checkbox"/>
4 Have you got a monkey?	<input type="checkbox"/>	<input type="checkbox"/>
5 Have you got a spider?	<input type="checkbox"/>	<input type="checkbox"/>
6 Have you got a snake?	<input type="checkbox"/>	<input type="checkbox"/>

3    Draw and colour. Then write the names of pets. **Students' answers.**

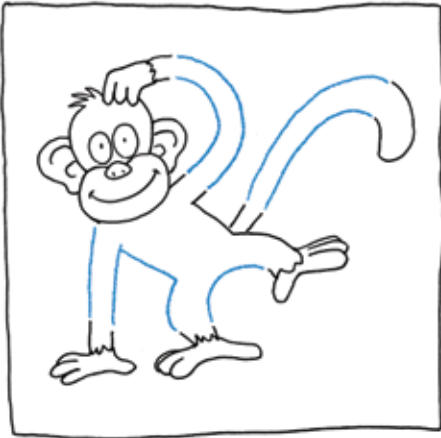

monkey

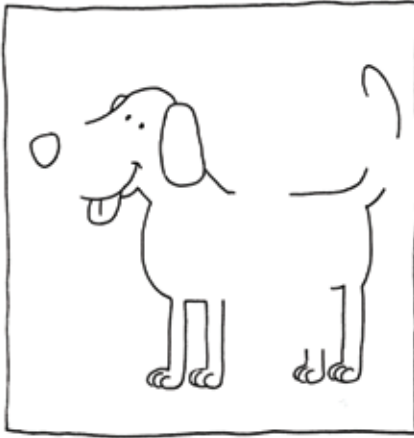

dog

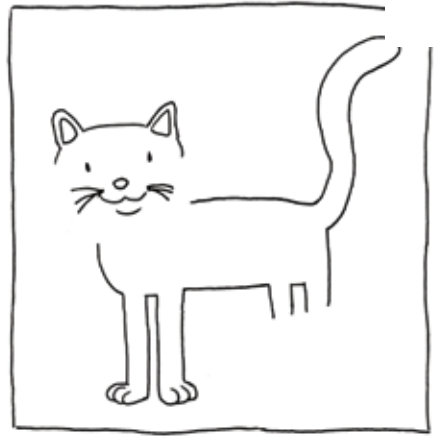

cat

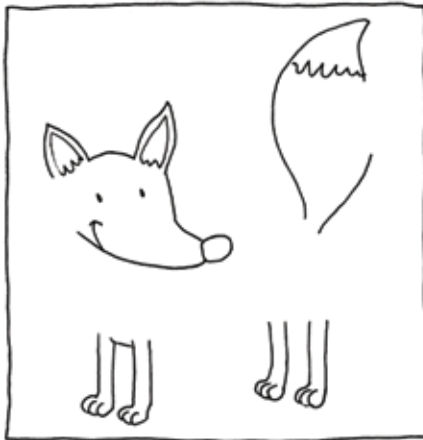

fox

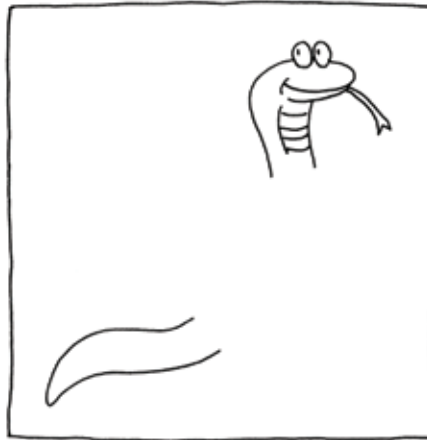

snake

LET'S CHECK!

1  Unscramble the words.

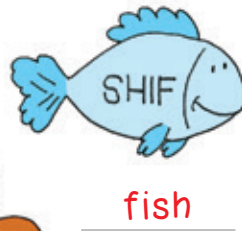
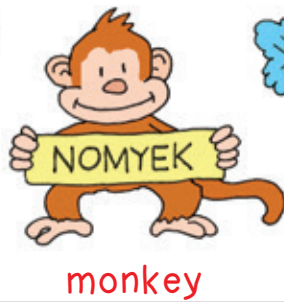
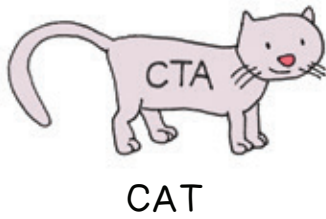

2  Write: **in**, **on** or **under**.



1 Gizmo is on the table.

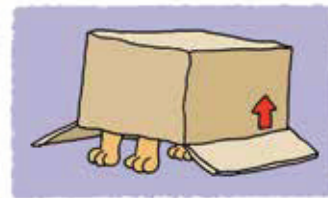

2 Gizmo is under the box.



3 Gizmo is under the chair.

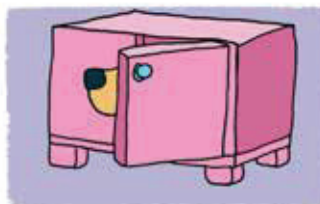

4 Gizmo is in the cupboard.



5 Gizmo is under the table.

3  Correct the sentences.

1 Poppy is a **parrot**.

Poppy is a cat

2 Tess is very **funny**.

Tess is very clever

3 Ronnie has got a **birthday** party.

Ronnie has got a tea party

4   Circle. How many words can you find?

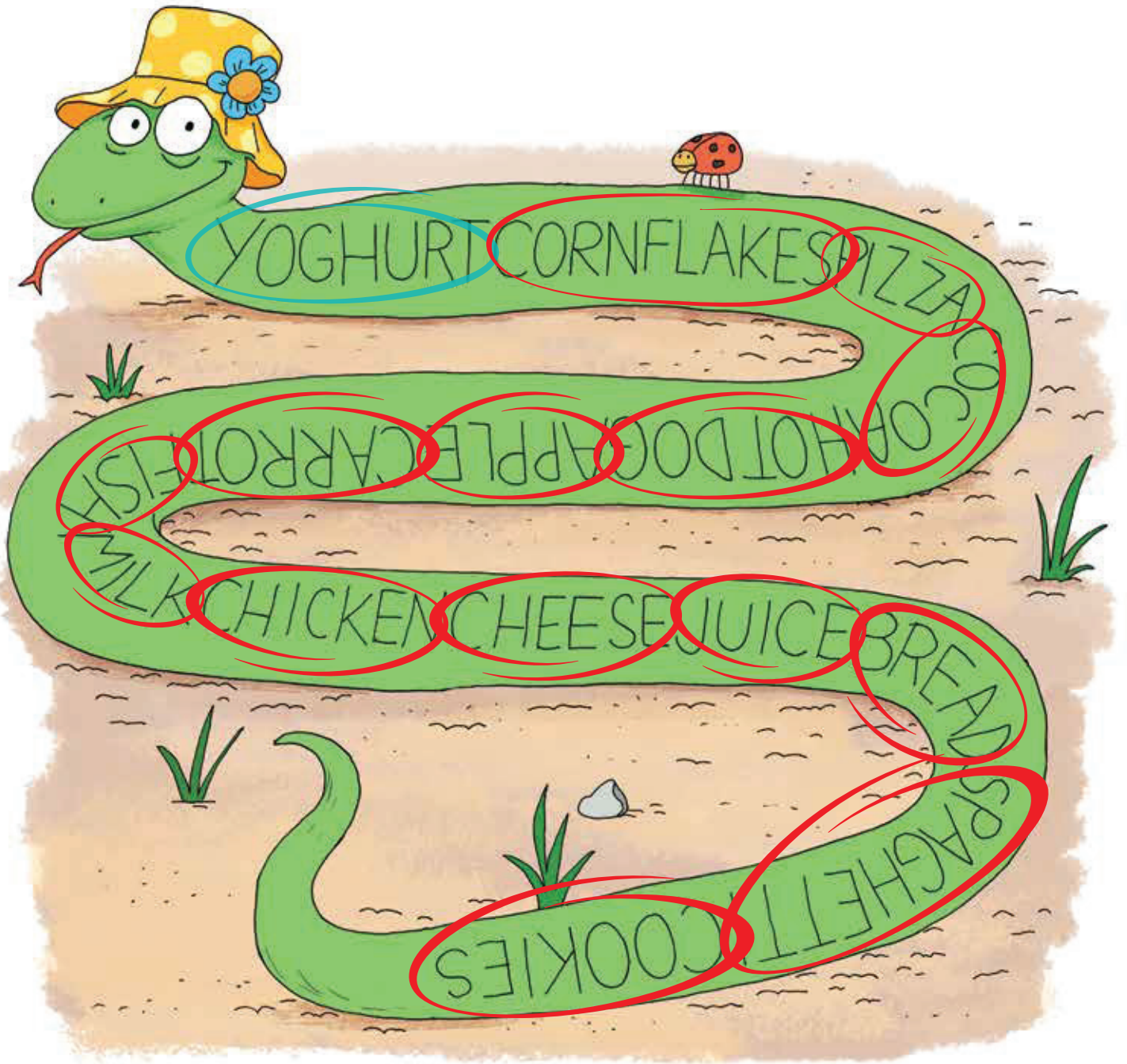

5  Write. **Students' answers.**

I have _____ for breakfast.

I have _____ for lunch.

I have _____ for dinner.

THE MISSING BABY TIGER

1 Write.



2 Circle.

- 1 The lion is... a) singing.
b) sleeping.
- 2 The monkey is... a) playing the guitar.
b) climbing a tree.
- 3 The zebra is... a) eating grass.
b) eating a pizza.
- 4 The kangaroo is... a) jumping.
b) flying.
- 5 The penguin is... a) watching TV.
b) swimming.
- 6 The parrot is... a) reading a book.
b) swinging.

3 Listen and check.

4 Write.

drinking milk

~~swinging~~

sleeping

eating an ice cream

climbing a tree

I'm swinging.



I'm climbing a tree.



I'm sleeping.

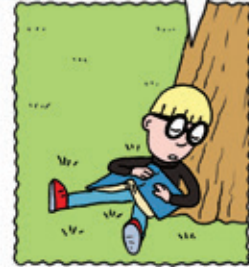

I'm eating an ice cream.



I'm drinking milk.

5 Match.

1 Where is the baby tiger?

Under the tree.

2 Where is Elliot?

Kim.

3 Who is drinking juice?

In the basket.

4 Who is eating an apple?

Miss Lemmon.

6 What's in the basket? Tick. Then colour the **odd one out**.



- | | | | |
|-------------------------------------|------------|-------------------------------------|--------------|
| <input type="checkbox"/> | a pizza | <input type="checkbox"/> | fish |
| <input checked="" type="checkbox"/> | a sandwich | <input checked="" type="checkbox"/> | juice |
| <input type="checkbox"/> | chicken | <input checked="" type="checkbox"/> | chocolate |
| <input checked="" type="checkbox"/> | an apple | <input checked="" type="checkbox"/> | milk |
| <input checked="" type="checkbox"/> | a banana | <input checked="" type="checkbox"/> | an ice cream |
| <input checked="" type="checkbox"/> | an orange | <input type="checkbox"/> | cocoa |

WHAT'S UP?

1 ✂ ✂ ✂ Cross out the mistake. Then write the correct word.



1 Uncle Phil is washing his ~~bike~~.
car



4 Greg is talking on the ~~computer~~.
phone.



2 Miss Lemmon is reading a ~~letter~~.
book.



5 Ronnie is eating a ~~banana~~.
carrot.



3 Jessica is playing the ~~guitar~~.
piano.

2 📖 📄 Read and stick.

1 Uncle Phil is washing his car .

2 Miss Lemmon is reading a book .

3 Jessica is playing the piano .

4 Greg is talking on the phone .

5 Ronnie is eating a carrot .

3  Stick.

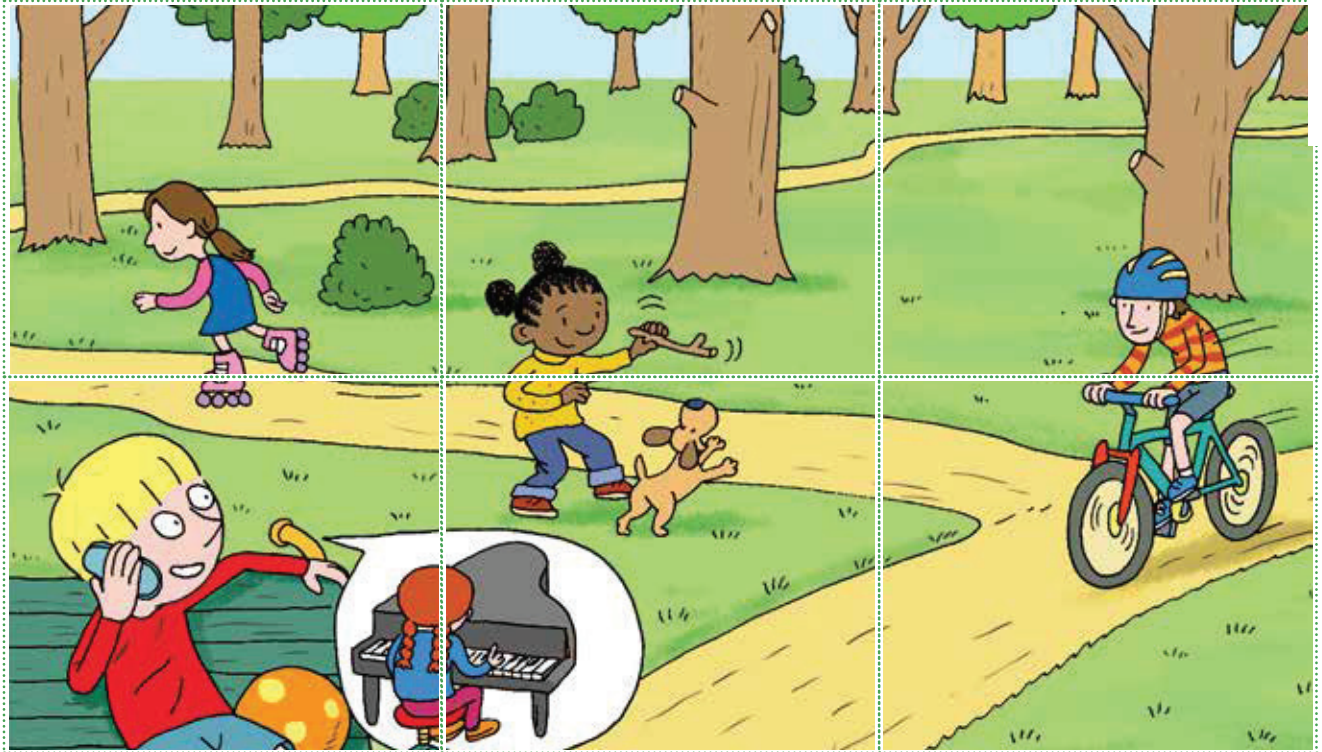

4  Write.

Greg

~~Susan~~

Kim

Luke

Jessica

- 1 Who is roller-skating?
- 2 Who is riding a bike?
- 3 Who is playing with Gizmo?
- 4 Who is playing the piano?
- 5 Who is talking on his mobile phone?

Susan

Luke

Kim

Jessica

Greg

5  Circle.

- 1 Is Jessica playing the piano?
- 2 Is Luke riding a horse?
- 3 Is Kim playing with her dog?
- 4 Is Greg climbing a tree?

Yes, she is. / No, she isn't.

Yes, he is. / ~~No, he isn't.~~

Yes, she is. / No, she isn't.

Yes, he is. / ~~No, he isn't.~~

SUPER SUZY

1   What is Super Suzy doing? Write and match.

1 Super Suzy	2 driving	3 riding	4 is
5 a bike	6 drinking	7 swimming	8 drawing
9 flying	10 super milk	11 her super car	12 reading
13 washing	14 roller-skating	15 a book	16 her super car

1 4 7 Super Suzy is swimming 

1 4 9 Super Suzy is flying 

1 4 8 Super Suzy is drawing 

1 4 14 Super Suzy is roller-skating 

1 4 3 5 Super Suzy is riding a bike 

1 4 12 15 Super Suzy is reading a book 

1 4 6 10 Super Suzy is drinking super milk 

1 4 13 11 Super Suzy is washing her super car 

1 4 2 16 Super Suzy is driving her super car 

2 Write.

~~I'm drawing a picture.~~

I'm driving a car.

I'm swimming.

I'm flying.

I'm drawing a picture.



I'm swimming.

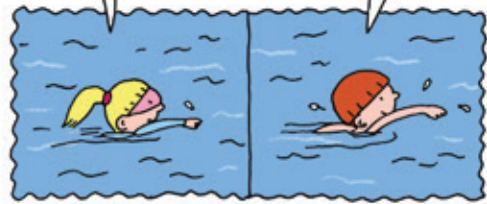

I'm driving a car.

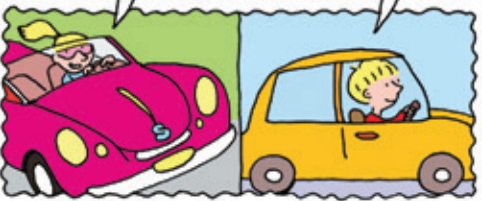

I'm flying.



3 What are you doing? Write and draw. Students' answers.

I'M SUPER _____.

Super Suzy,
wheezy-woo,
I'm _____
and so are you!

KIM'S SONG

1 Listen and put the pictures in the right order.

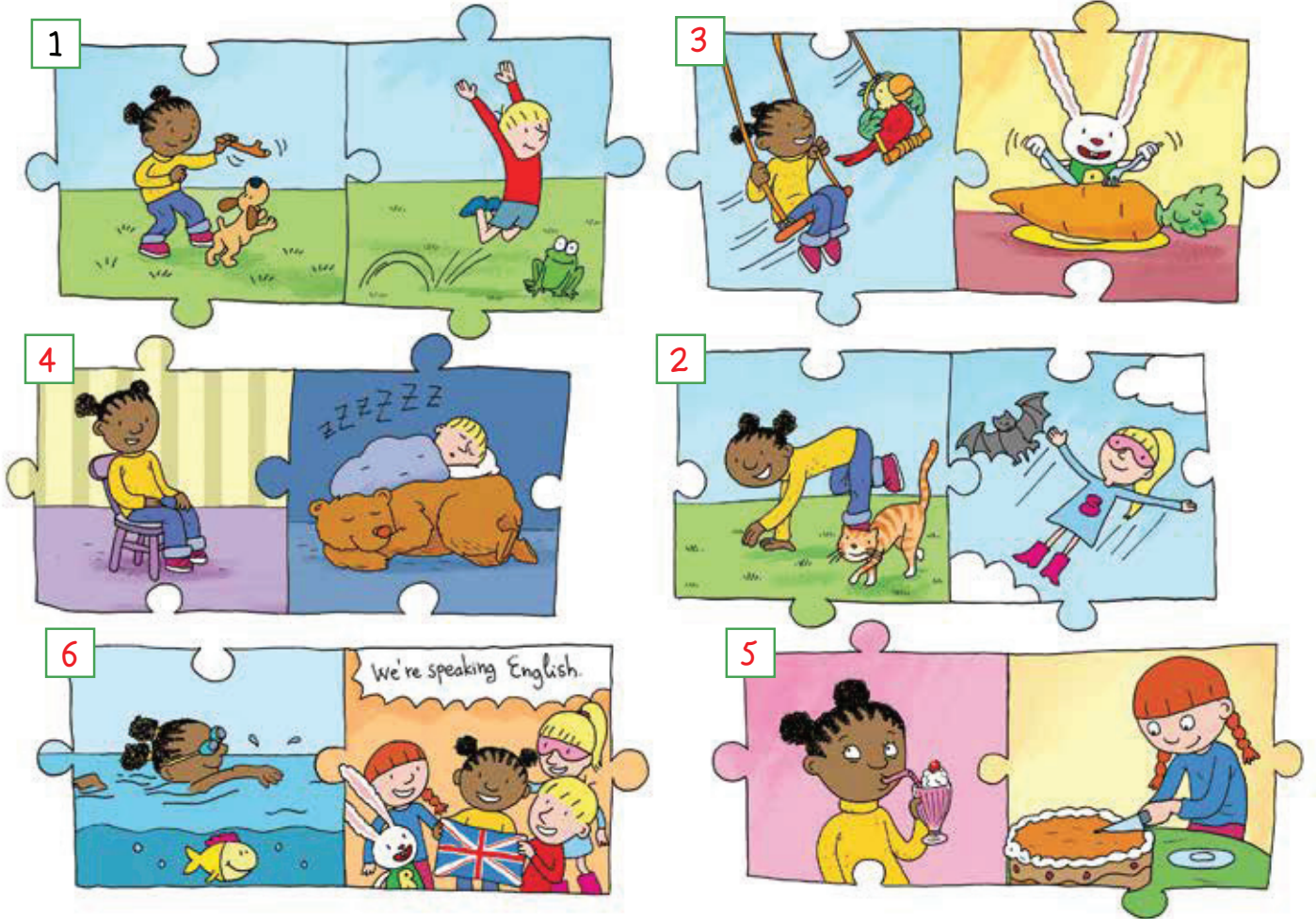

2 Match.

1 I'm playing with a dog.

2 I'm walking like a cat.

3 I'm swinging like a parrot.

4 I'm sitting on the chair.

5 I'm drinking a milkshake.

6 I'm swimming like a fish.

He's eating a big carrot.

She's flying like a bat.

She's cutting a big cake.

We're speaking English.

He's jumping like a frog.

He's sleeping like a bear.

3   Match and write.

- a bear
- a cat
- a cake
- ~~a frog~~
- a parrot
- a milkshake
- ~~a dog~~
- English
- a carrot
- a bat

Which words rhyme?



- a fish
- a chair

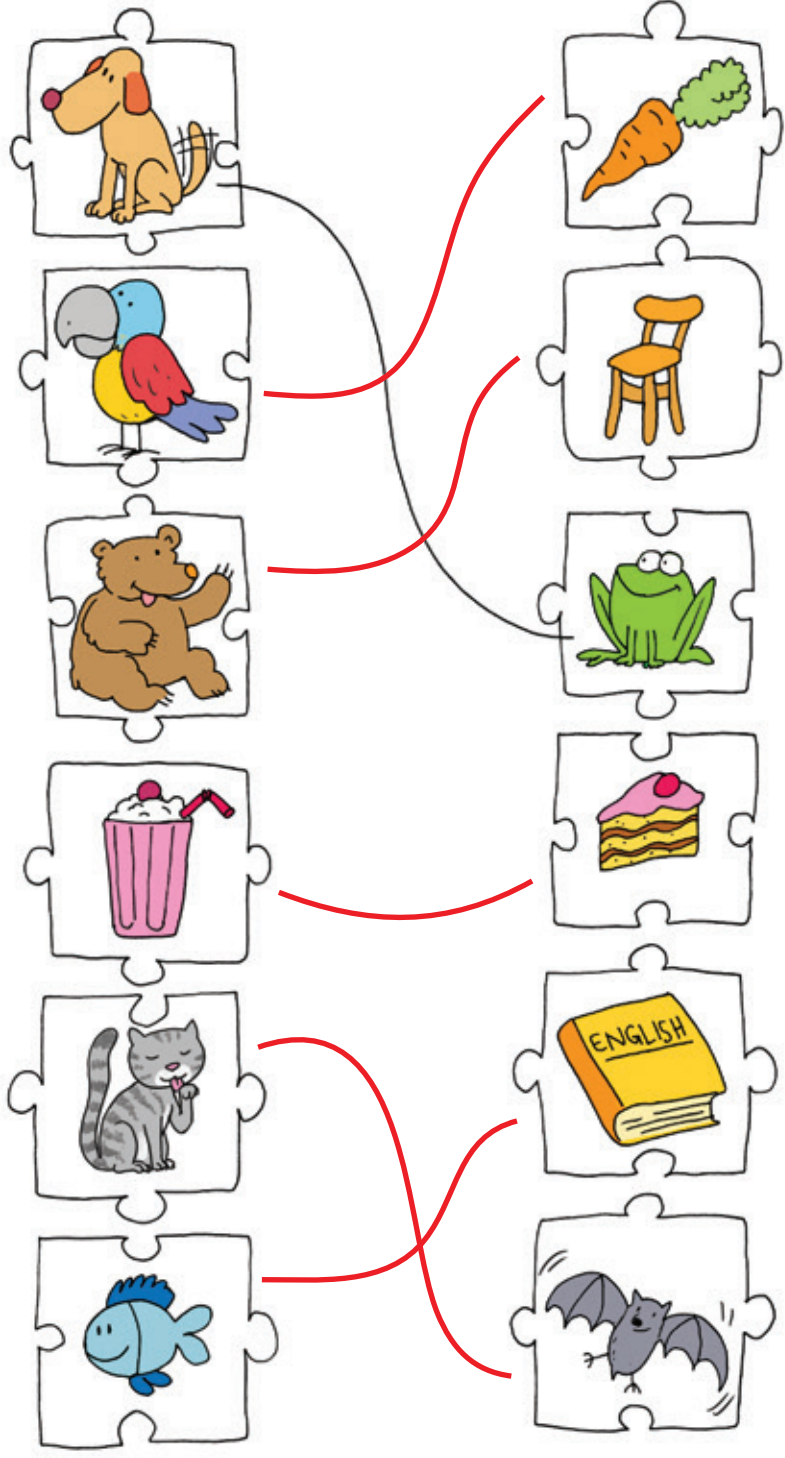



Which words rhyme?

a dog	a frog
a parrot	a carrot
a bear	a chair
a milkshake	a cake
a cat	a bat
a fish	English

LET'S CHECK!

1  Do you remember the Actions Board Game? Match.

1 Who is flying?	Uncle Phil.
2 Who is roller-skating?	Super Suzy.
3 Who is swimming?	Elliot.
4 Who is washing his car?	A penguin.
5 Who is sleeping?	A kangaroo.
6 Who is jumping?	Susan.

2   Listen and circle. Then stick.

1



Kim is reading a) a letter.
 b) a book.
 c) a comic book.

2



Jessica is playing a) the piano.
 b) the guitar.
 c) with a dog.

3



Ronnie is eating a) ice cream.
 b) a carrot.
 c) a sandwich.

4

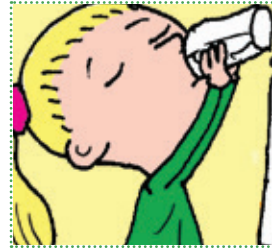

Super Suzy is drinking a) tea.
 b) juice.
 c) her super milk.

5







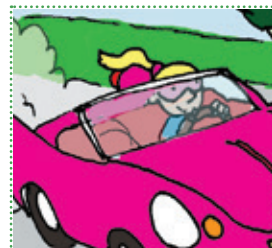















Luke is riding a) a zebra
 b) a bike.
 c) a horse.

6



Super Suzy is driving a) her super car.
 b) a train.
 c) a bus.

3   Copy the right words and draw.

one		six		eleven		sixteen	
two		seven		twelve		seventeen	
three		eight		thirteen		eighteen	
four		nine		fourteen		nineteen	
five		ten		fifteen		twenty	

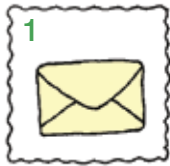

one

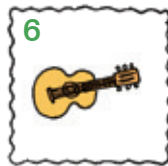

six



eleven



sixteen

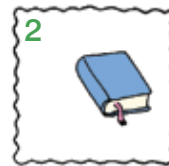

two



seven



twelve



seventeen



three



eight



thirteen



eighteen

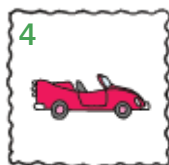

four



nine



fourteen



nineteen



five



ten

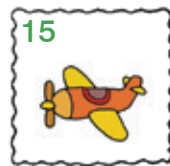



















fifteen



twenty

A SUMMER PINBOARD

1 Match.

a bridge    a jungle
 rain    a boat
 sunny    an alligator
 a shark    a bet
 teeth    a castle
 scared    spooky

2 Write and colour. **Students' answers.**

~~raining~~

shining

looking

flying

standing

visiting

rowing

riding

①

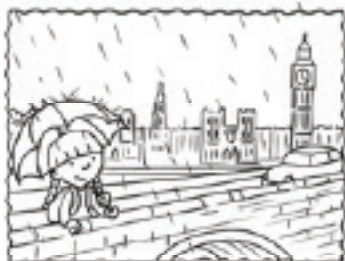

It's raining. Jessica is standing on a bridge in London. She has got an umbrella. She likes rain very much.

②



The sun is shining.
 Uncle Phil and Ronnie are in the jungle. They are rowing a boat. An alligator is looking at them!

③

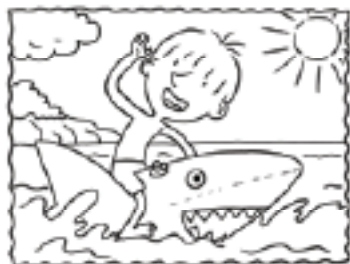

It's hot and sunny. Greg is riding a big shark. It has got big teeth, but Greg is not scared. It's just a toy shark.

④



It's evening. The bats are flying. Elliot and his family are visiting an old castle. It looks spooky! April is happy, but Elliot is scared.

3 Write the correct sentences.

They are sleeping.

They are running away.

She is dancing in the rain.

He is eating an ice cream.

1 Look at Jessica now! She is not standing on a bridge.

She is dancing in the rain.



2 Look at Greg now! He is not riding a big shark.

He is eating an ice cream.



3 Look at Uncle Phil and Ronnie now! They are not rowing a boat.

They are running away.



4 Look at the bats now! They are not flying.

They are sleeping.



4 Circle the correct answer.



Kim is is not eating an ice cream.



Gizmo is is not swimming.



Kim is is not sleeping.



Kim is is not making a sandcastle.



Gizmo is is not eating a bone.



Kim and Gizmo are are not going home.

UNCLE PHIL'S TRIP

1  Match.

tea banana camel boat palm tree igloo

1 2 3 4 5 6

2  Complete the sentences. Use **the** words from Task 1.



I'm eating a banana.



I'm sitting under a palm tree.



I'm drinking tea.



I'm riding a camel.



I'm building an igloo.



I'm rowing a boat.

3  Circle the correct answer.



I'm I'm not drinking tea.

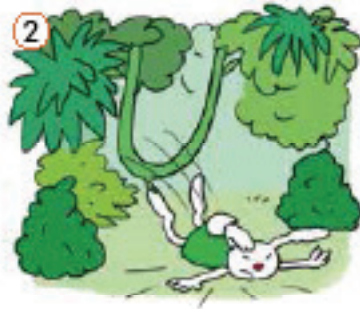

I'm I'm not swinging.



I'm I'm not rowing a boat.



I'm I'm not building an igloo.



I'm I'm not eating a banana.

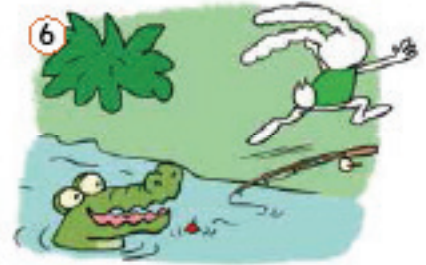

I'm I'm not fishing.

4  Listen and tick.

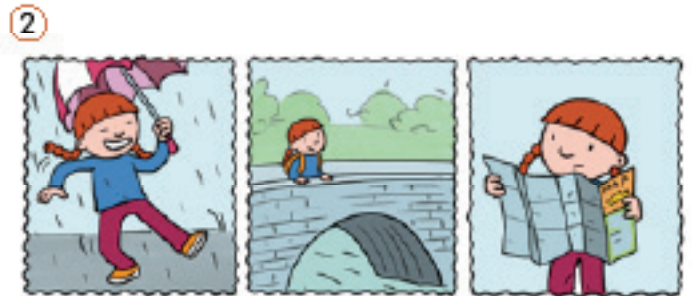
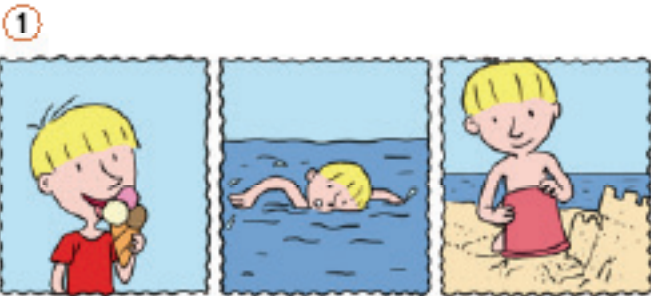

PIXY'S NEW COAT

1  Match.



Who is Pixy?



What colour is his coat?



Where is Pixy now?



What colour is his new coat?



Why is Pixy sad?



Who has got a parasol for Pixy?



What is Pixy wearing again?

- 
- 3 In the shop.
 - 7 His black and white coat.
 - 1 A penguin.
 - 6 His friends.
 - 2 Black and white.
 - 5 Because his friends are laughing.
 - 4 Green.

2   Read and colour. **Students' answers.**



It's sunny. Pixy is wearing yellow shorts, a red T-shirt and a pink cap.





It's raining. Pixy is wearing an orange raincoat and green boots.



It's windy. Pixy is wearing a pink jacket and black trainers.



It's snowing. Pixy is wearing a blue coat and a red scarf.

3    Dress Pixy up. What is he wearing? **Students' answers.**

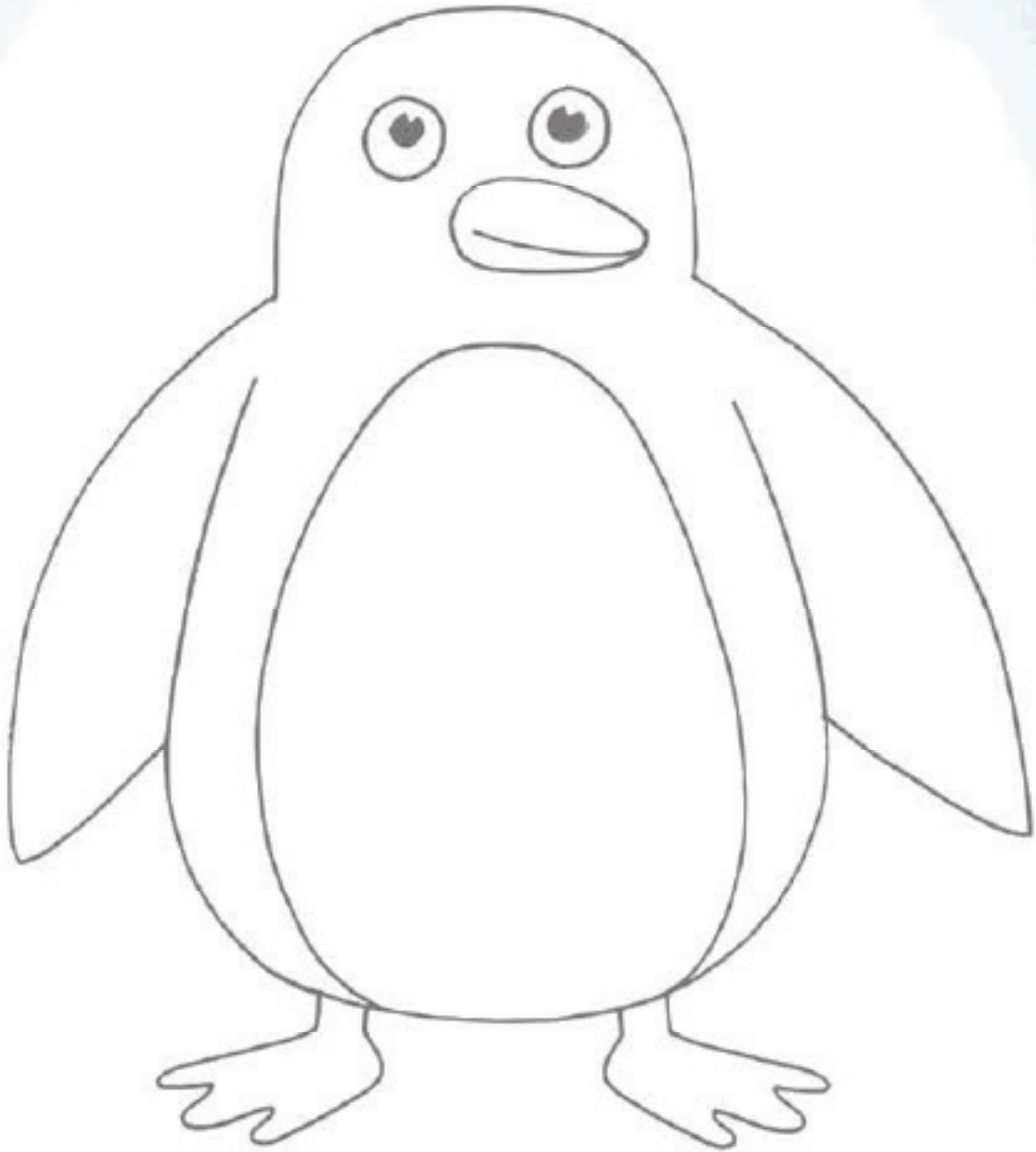

Pixy is wearing _____

4 Write.

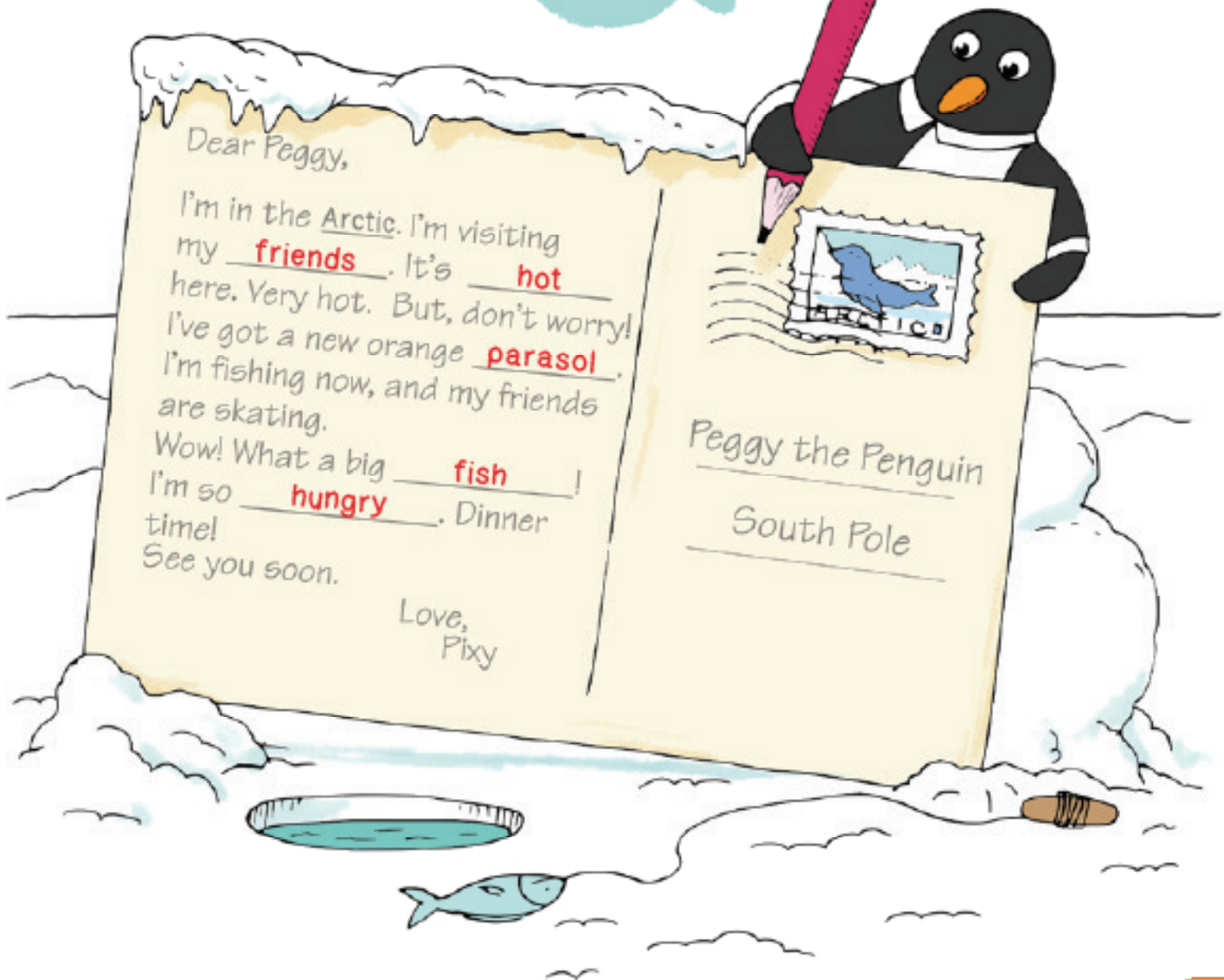

Dear Peggy,

I'm in the Arctic. I'm visiting
my friends. It's hot
here. Very hot. But, don't worry!
I've got a new orange parasol.
I'm fishing now, and my friends
are skating.
Wow! What a big fish!
I'm so hungry. Dinner
time!
See you soon.

Love,
Pixy



Peggy the Penguin

South Pole

THE SUMMER RAP

1  Read and put the sentences in the right order.

The Summer Rap

- 5 It is hot, it is hot!
- 8 But now it's time to fly away.
- 2 I would like to be the king.
- 1 Uncle Phil, let me swing!
- 6 I would like a summer coat.
- 4 I would like a cup of tea!
- 7 It was fun, I must say,
- 3 I'm so thirsty, look at me!



2  Write the missing lines from Task 1.



Uncle Phil, let me swing!

I would like to be the king.



I'm so thirsty, look at me!

I would like a cup of tea!



It is hot, it is hot!

I would like a summer coat.



It was fun, I must say,

But now it's time to fly away.

3 Match.

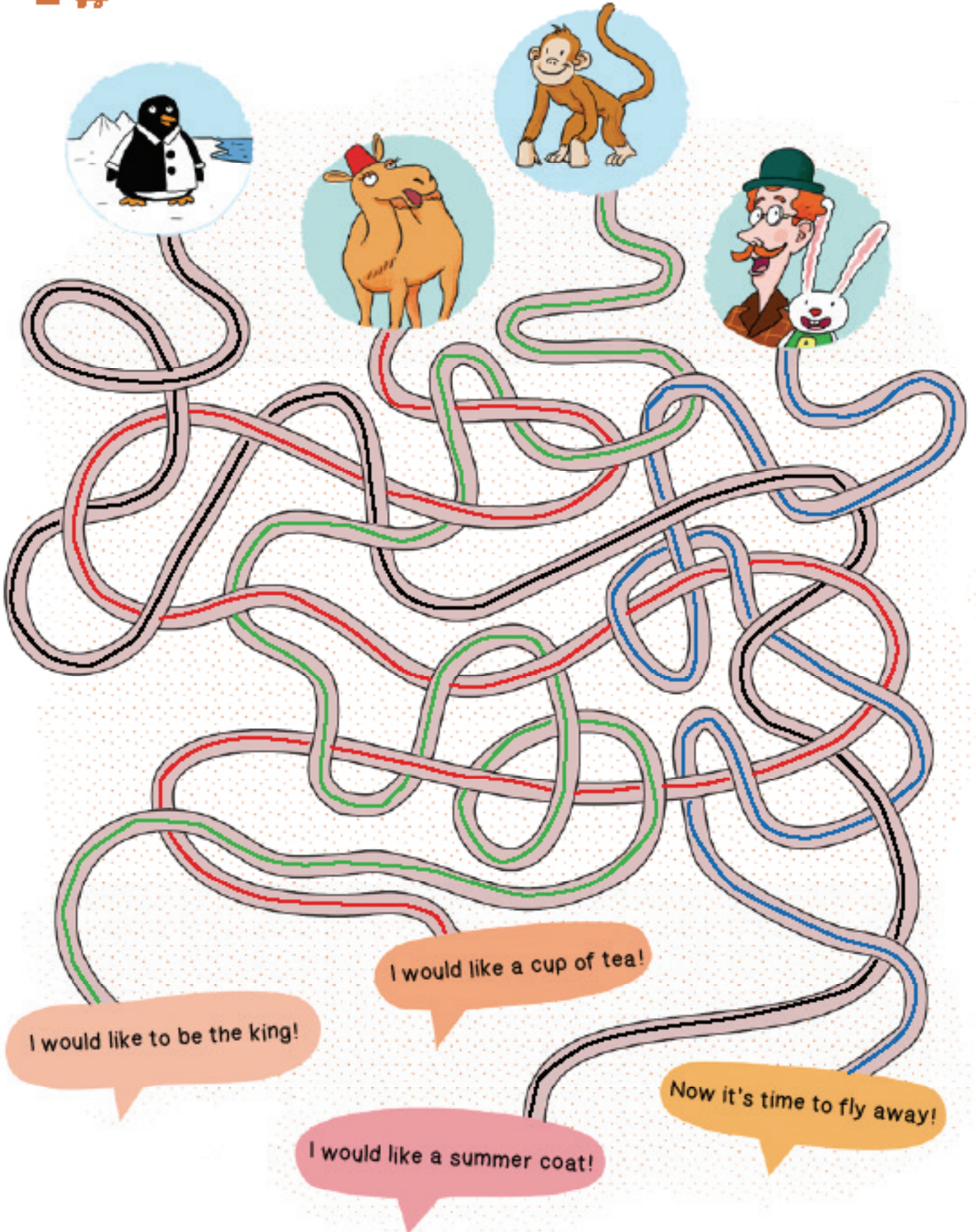

LET'S CHECK!

1  Copy the right answers.



He is fishing.

Six.

Indian costumes.

A bone.

Two

A bike.

A girl.

One.

~~Susan.~~

In the basket.

- 1 Who is writing a postcard?
- 2 What is Luke doing?
- 3 How many boys are playing football?
- 4 Where is the cat sleeping?
- 5 What is the dog eating?
- 6 How many birds are sitting in the tree?
- 7 What is the boy riding?
- 8 What are some children wearing?
- 9 Who is swinging: a boy or a girl?
- 10 How many girls are swimming?

Susan.

He is fishing.

Six.

In the basket.

A bone.

One.

A bike.

Indian costumes.

A girl.

Two.

2 Look at the picture. What's going on now? Circle the correct answer.



- 1 Susan is writing / is not writing a postcard.
- 2 Luke is fishing is not fishing.
- 3 The boys are playing / are not playing football.
- 4 The cat is sleeping / is not sleeping.
- 5 The dog is eating / is not eating a bone.
- 6 The bird is singing / is not singing.
- 7 The boy is riding / is not riding bike.
- 8 The children are dancing / are not dancing.
- 9 The girl is swinging / is not swinging.
- 10 The two girls are swimming / are not swimming.

A NEW CLASSROOM

1  Copy the right words.



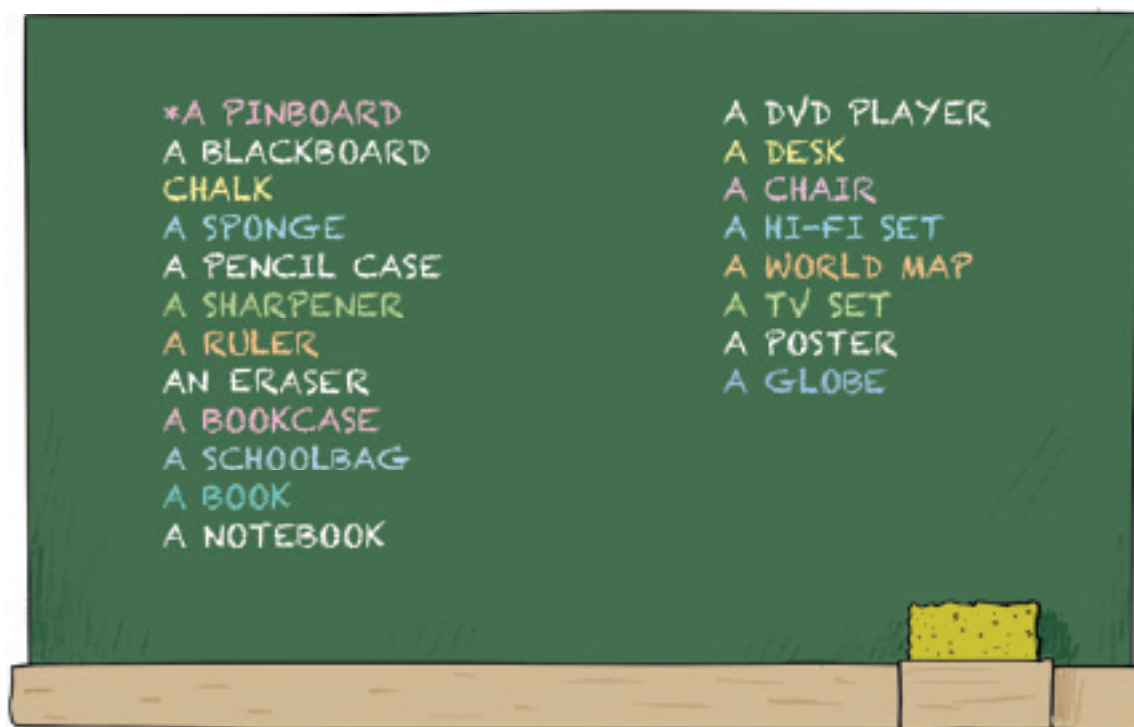

*A PINBOARD
A BLACKBOARD
CHALK
A SPONGE
A PENCIL CASE
A SHARPENER
A RULER
AN ERASER
A BOOKCASE
A SCHOOLBAG
A BOOK
A NOTEBOOK

A DVD PLAYER
A DESK
A CHAIR
A HI-FI SET
A WORLD MAP
A TV SET
A POSTER
A GLOBE

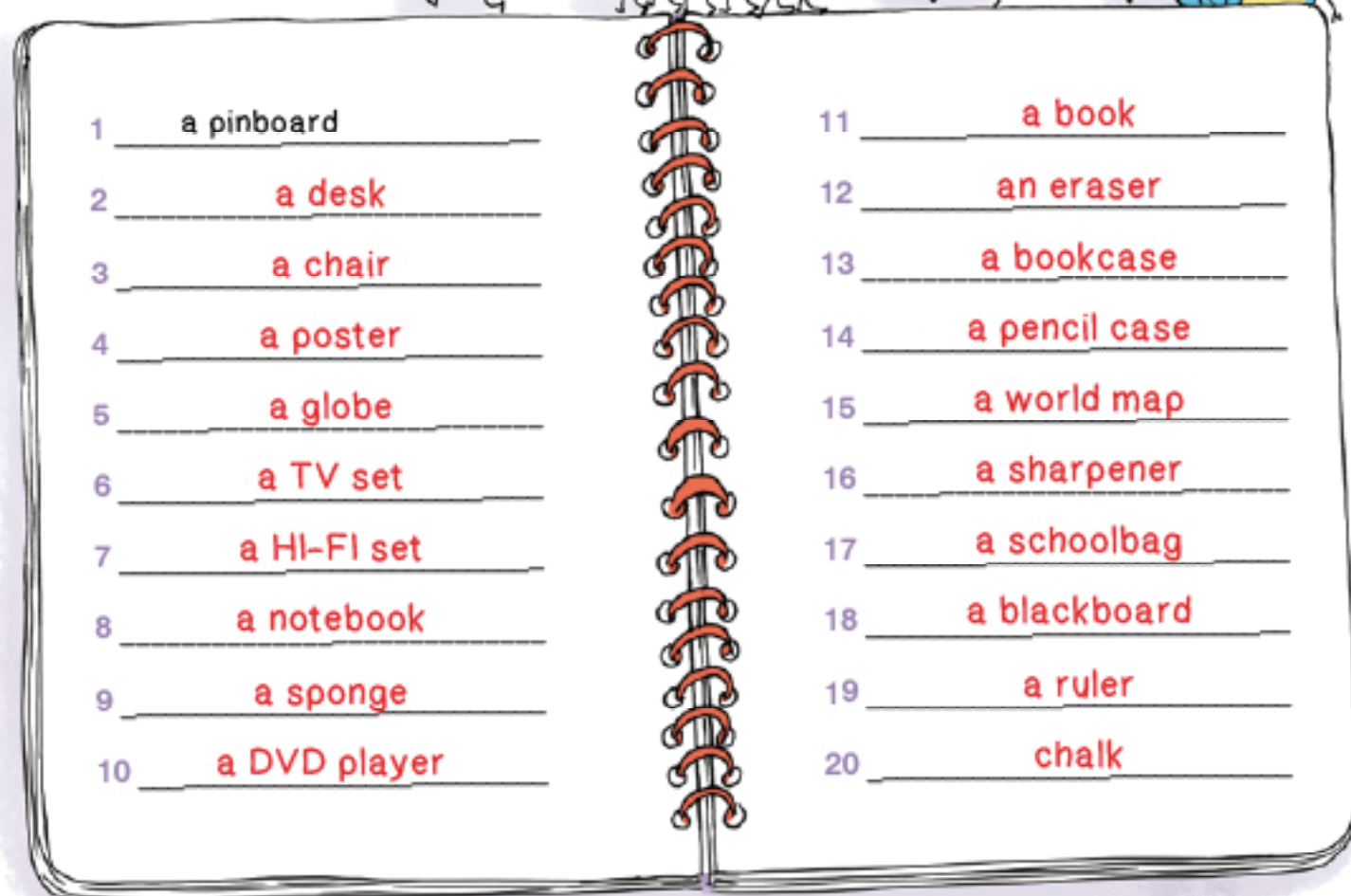
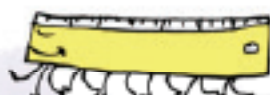

1 a pinboard
2 a desk
3 a chair
4 a poster
5 a globe
6 a TV set
7 a HI-FI set
8 a notebook
9 a sponge
10 a DVD player

11 a book
12 an eraser
13 a bookcase
14 a pencil case
15 a world map
16 a sharpener
17 a schoolbag
18 a blackboard
19 a ruler
20 chalk

2  Circle the correct answer.

1 There is a globe on the teacher's desk.
There are

2 There is a blackboard on the wall.
There are

3 There is pencils in the pencil case.
There are

4 There is some posters on the wall.
There are

5 There is a DVD player under the TV set.
There are

6 There is many books in the bookcase.
There are

3  Write: in, on or under.

1 There is a sponge on the floor.

4 There are notebooks on the desk.

2 There is a ruler on the desk.

5 There are many books in the bookcase.

3 There is a schoolbag under the desk.

6 There is a HI-FI set under the TV set.

4  Write about your classroom. **Students' answers.**

MY CLASSROOM

There is _____.

There is _____.

There are _____.

There are _____.

5 Write the correct sentences.



Do you remember
The Classroom Song?

There is
There are

a mouse
a poster
books
a sponge
a pinboard
a world map

on the wall.
on the desk.
on the floor.
on the wall.
in the schoolbag.
on the door.

There is a mouse in the schoolbag.

There is a poster on the door.

There are books on the desk.

There is a sponge on the floor.

There is a pinboard on the wall.

There is a world map on the wall.

6 Listen to The Classroom Song and check.

7 Draw and colour. **Students' answers.**

There are three books on
the teacher's desk.

There is a ruler in the schoolbag.

There is a notebook on the floor.

There are six pencils
in the pencil case.

There is a globe on the cupboard.

There is a ball under the chair.





MATHS RIDDLES

1  Stick.

1	one	11	eleven
2	two	12	twelve
3	three	13	thirteen
4	four	14	fourteen
5	five	15	fifteen
6	six	16	sixteen
7	seven	17	seventeen
8	eight	18	eighteen
9	nine	19	nineteen
10	ten	20	twenty



2  Now listen and check.

3  Write the numbers.

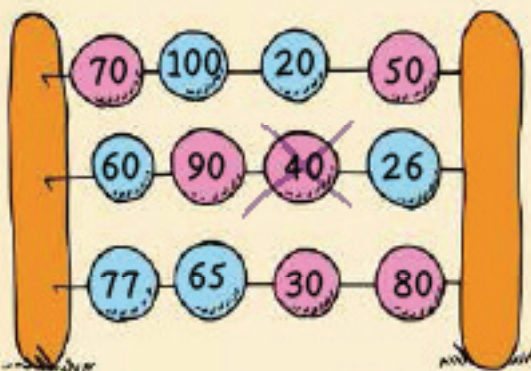
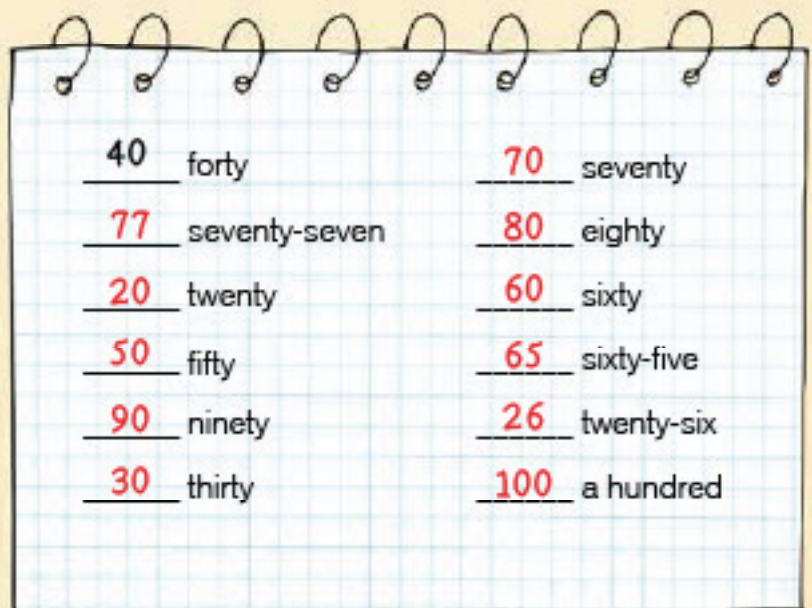
<u>40</u> forty	<u>70</u> seventy
<u>77</u> seventy-seven	<u>80</u> eighty
<u>20</u> twenty	<u>60</u> sixty
<u>50</u> fifty	<u>65</u> sixty-five
<u>90</u> ninety	<u>26</u> twenty-six
<u>30</u> thirty	<u>100</u> a hundred



4  Numbers Bingo Play the game. **Students' answers.**



5  Draw.

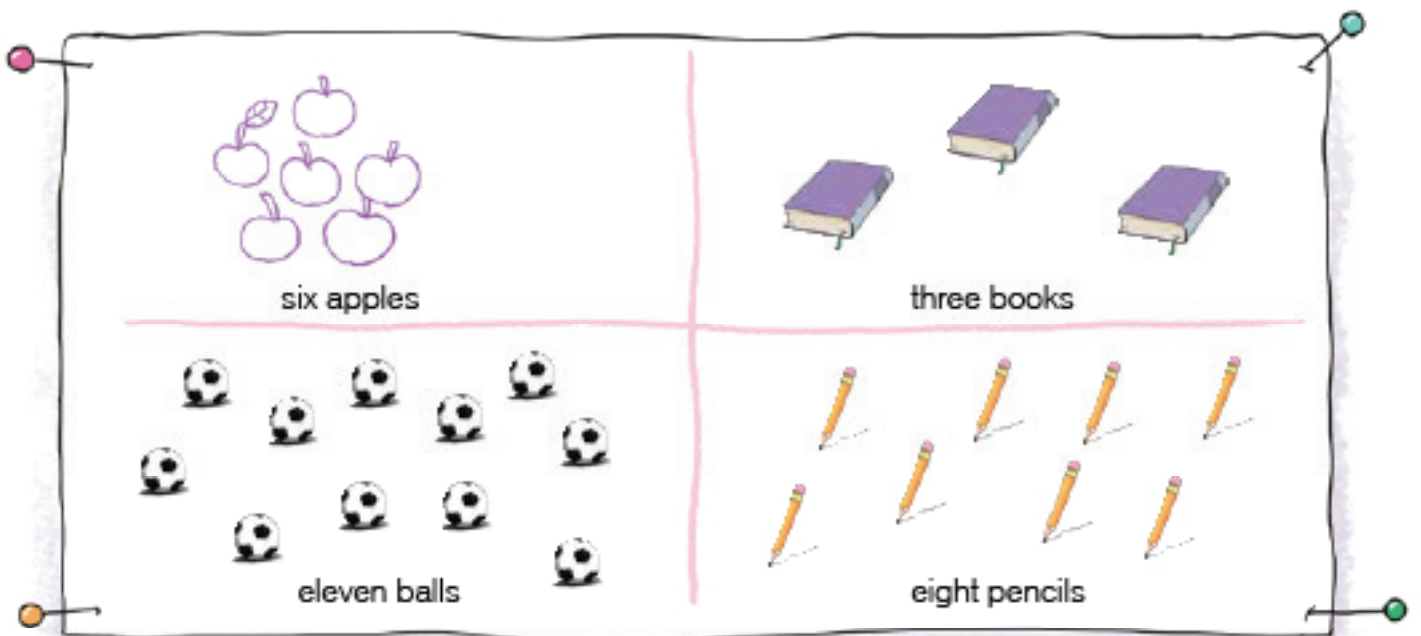

6  Count and write the numbers.

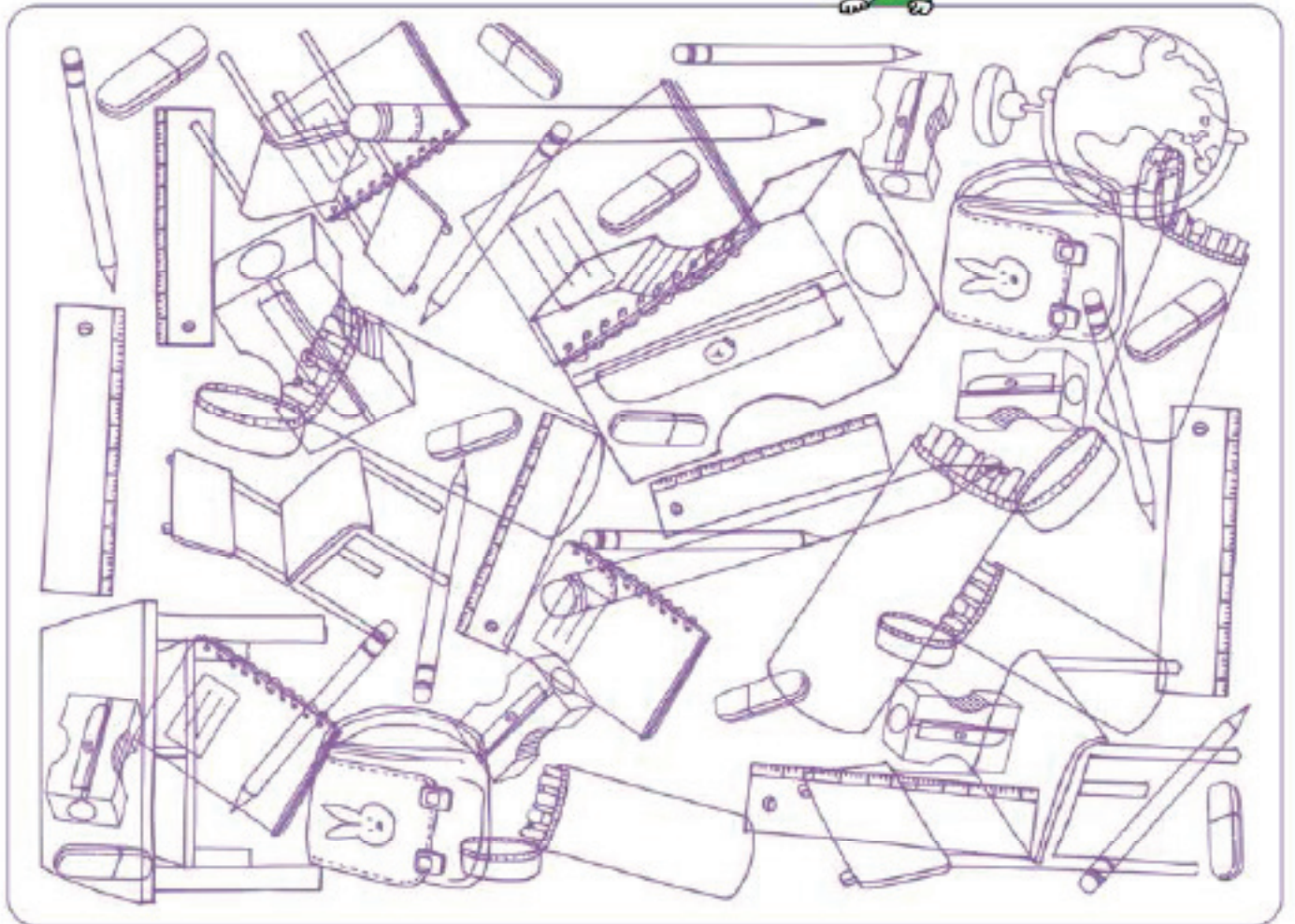

1 globe

7 sharpeners

9 erasers

10 pencils

5 pencil cases

4 notebooks

6 rulers

2 schoolbags

3 chairs

7  Solve the maths riddles.

① There are fifteen birds in the tree.



Seven birds fly away.

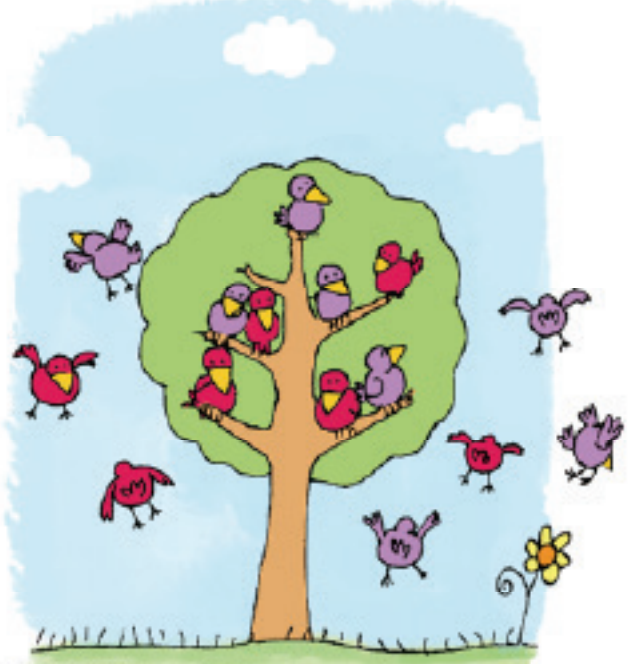

How many birds are there in the tree now?

ANSWER: There are eight birds
in the tree

② There are seventeen books in the bookcase.



I get three books for my birthday.



How many books are there in the bookcase now?

ANSWER: There are twenty books
in the bookcase

MEET MS SPRINGFIELD

1 Write: **is**, **has got** or **likes**.

1



Ms Springfield **has got** blonde hair and big blue eyes.

2

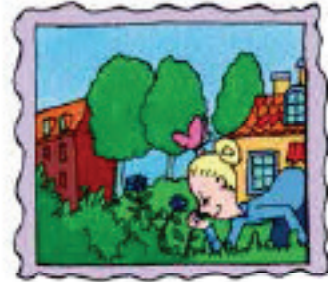

Her favourite flower **is** the blue rose. Blue is her favourite colour.

3



Ms Springfield **is** very romantic. She **likes** music and poetry. She likes singing, too.

4



Ms Springfield **likes** computers. She likes writing stories on her computer, but she doesn't like playing computer games.

5



Ms Springfield has got a special hobby. It's horse riding. She **has got** a lot of medals.

6



Today Ms Springfield **is** wearing her favourite blue dress.

2 Now listen and check.

3 Write more sentences about Ms Springfield.



Ms Springfield likes...

summer
football
spring
ice cream

Ms Springfield doesn't like...

hamburgers
spiders
winter
boxing

4 What about you? Write.

Students' answers.



I like...



I don't like...

ONE, TWO, ...

1  Put the pictures in the right order.

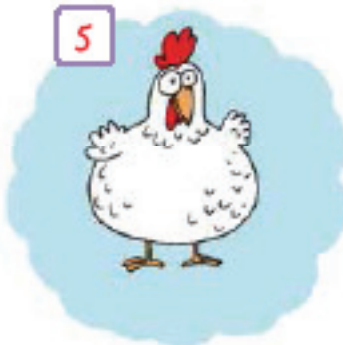

2  Now listen to the rhyme and check.

3  Match.

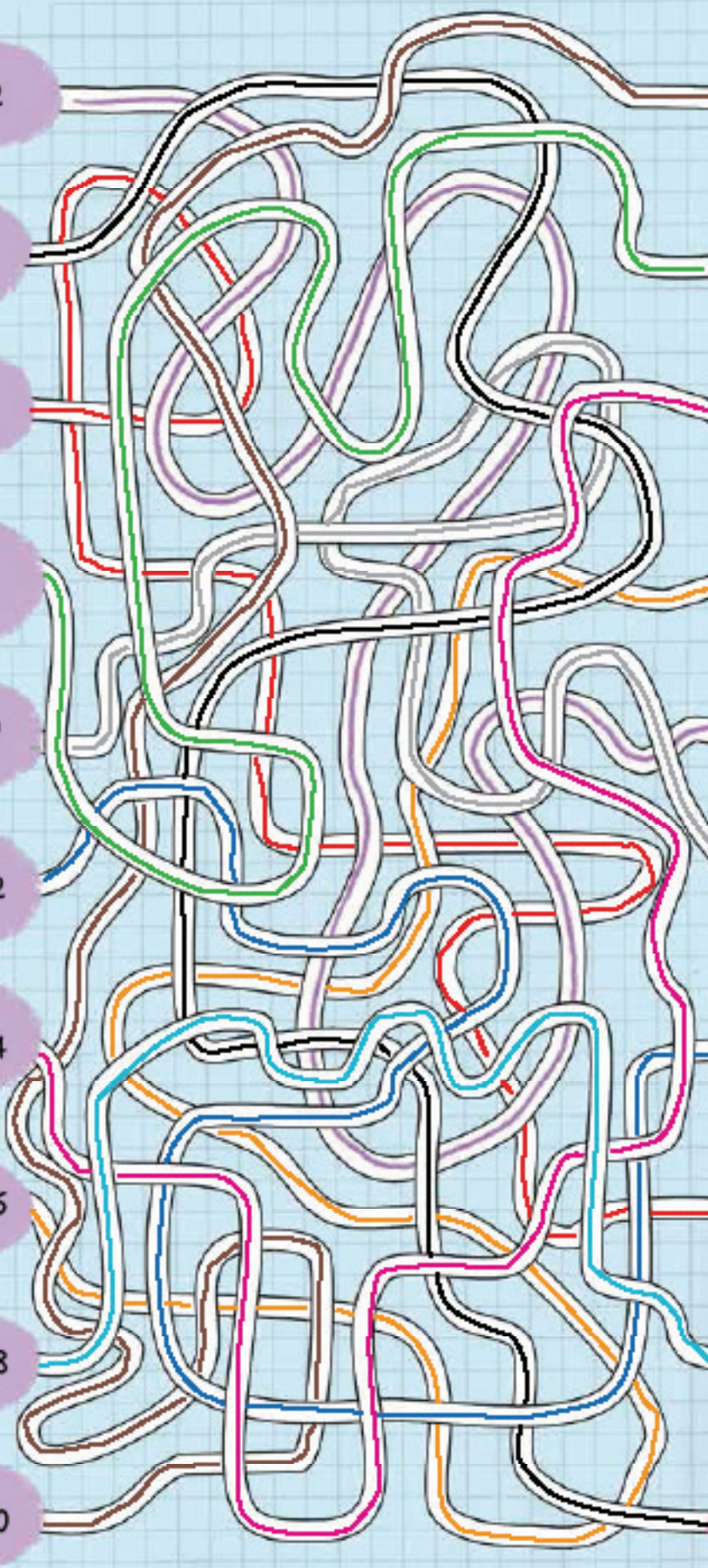

1, 2

3, 4

5, 6

7, 8

9, 10

11, 12

13, 14

15, 16

17, 18

19, 20

My plate is empty.

Lay them straight.

Maids a-courting.

Maids in the kitchen.

Buckle my shoe.

A good fat hen.

Dig and delve.

Pick up sticks.

Maids a-waiting.

Knock on the door.

LET'S CHECK!

1   Write the correct answers. Then match the answers with the right pictures.

1 She	2 There	3 favourite	4 wearing	5 music	6 pencils
7 in	8 poetry	9 her	10 sixteen	11 is	12 On
13 horse riding	14 are	15 and	16 books	17 the bookcase	18 the teacher's desk
19 computers	20 twelve	21 the pencil case	22 dress	23 blue	24 likes

1 What is Ms Springfield wearing?

1 - 11 - 4 - 9 - 3 - 23 - 22

She is wearing her favourite blue dress.

2 How many books are there in the bookcase?

2 - 14 - 10 - 16 - 7 - 17

There are sixteen books in the bookcase.

3 What does Ms Springfield like?

1 - 24 - 5 - 8 - 19 - 15 - 13

She likes music, poetry, computers and horse riding.

4 Where is the globe?

12 - 18

On the teacher's desk.

5 I've got 15 pencils in the pencil case. I put three pencils on the desk. How many pencils are there in the pencil case now?

2 - 14 - 20 - 6 - 7 - 21

There are twelve pencils in the pencil case.



2 Play the game.

Are you ready for more Noughts and Crosses?



Circle the correct answer:
There is or There are.



There is / There are
a globe on the desk.



There is / There are
ten carrots in the basket.



There is / There are
five books on the desk.

Say these numbers.

67
sixty-seven

95
ninety-five

46
forty-six

Fill in with:
is, has got or likes.



Ms Springfield is
the new teacher.



Ms Springfield has got
a beautiful garden.



Ms Springfield likes
music.

WHAT CAN ROBBIE DO?

1  Write about Robbie.

Robbie can	make	books.
	wash	football.
	play	basketball.
	read	tennis.
		the dishes.
		pancakes.
		the beds.
		the violin.

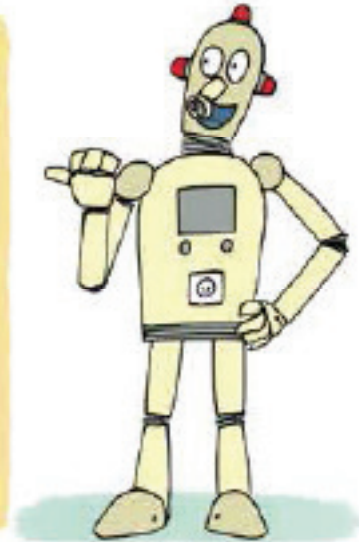

1 Robbie can make the beds.

2 Robbie can make pancakes.

3 Robbie can wash the dishes.

4 Robbie can play football.

5 Robbie can play basketball.

6 Robbie can play tennis.

7 Robbie can play the violin.

8 Robbie can read books.

2   What about you? Write and draw.

Students' answers.

I can make...

I can play...

I can read...

I can wash...

3 Write: **can** or **can't**.

1 Robbie **can** play tennis.

2 Robbie **can** play football.

3 Robbie **can** play basketball.

4 Robbie **can** read books.

5 Robbie **can** make the beds.

6 Robbie **can** wash the dishes.

7 Robbie **can't** play ice hockey.

8 Robbie **can** play the violin.

9 Robbie **can** make pancakes.

10 Robbie **can't** cook.

4 Do the crossword and sort out the words.

pancakes

dishes

book

beds

tennis

football

basketball

ice hockey

violin

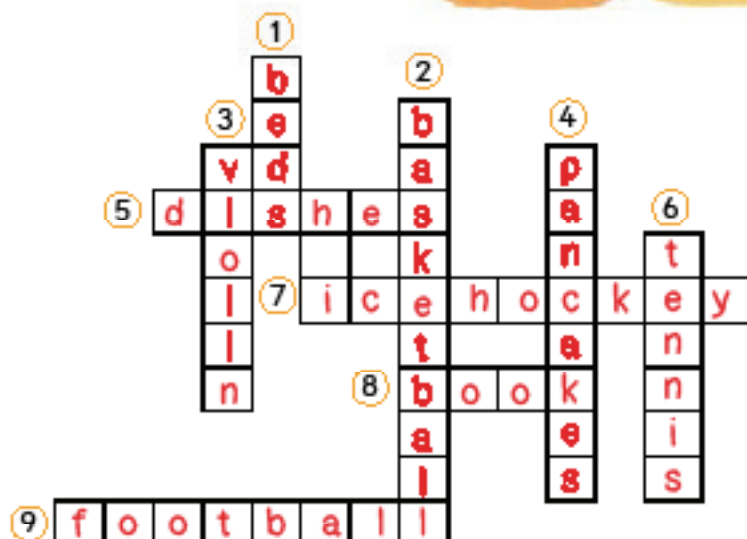

MAKE	PLAY	READ	WASH
<u>the beds</u> <u>pancakes</u>	<u>basketball</u> <u>the violin</u> <u>tennis</u> <u>ice hockey</u> <u>football</u>	<u>a book</u>	<u>the dishes</u>

5 What **can** you do? What **can't** you do? **Students' answers.**

I can _____

I can't _____

6  What about Ronnie? Circle the correct answers.

1



Ronnie can
can't play volleyball.

2



Ronnie can
can't play ice hockey.

3



Ronnie can
can't make pancakes.

4



Ronnie can
can't play football.

5



Ronnie can
can't wash the dishes.

6



Ronnie can
can't make a sandwich.

7



Ronnie can
can't read a book.

8



Ronnie can
can't ride a bike.

9



Ronnie can
can't play the violin.

7  Complete Robbie's sentences.

I can make a mess.



I can read a book.



I can climb a tree.



some tea chess

I can play the drums.

I can wash the dishes.



the drums

the dishes

a mess

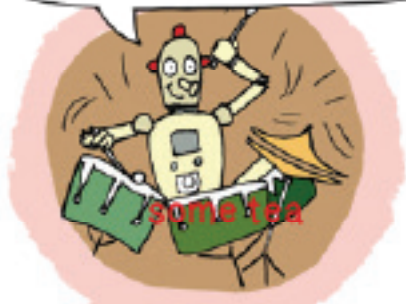

~~a book~~

a bike

a tree

I can play chess.



I can ride a bike.

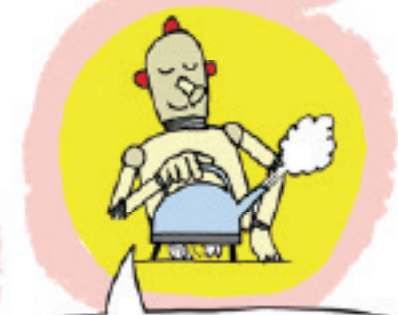

I can make some tea.

8  Write: **Yes, I can.** or **No, I can't.** **Students' answers.**

1 Can you read a book? _____.

5 Can you ride a bike? _____.

2 Can you climb a tree? _____.

6 Can you play chess? _____.

3 Can you play the drums? _____.

7 Can you wash the dishes? _____.

4 Can you make some tea? _____.

8 Can you make a mess? _____.

A BUSY WEEK



1  Complete the sentences.





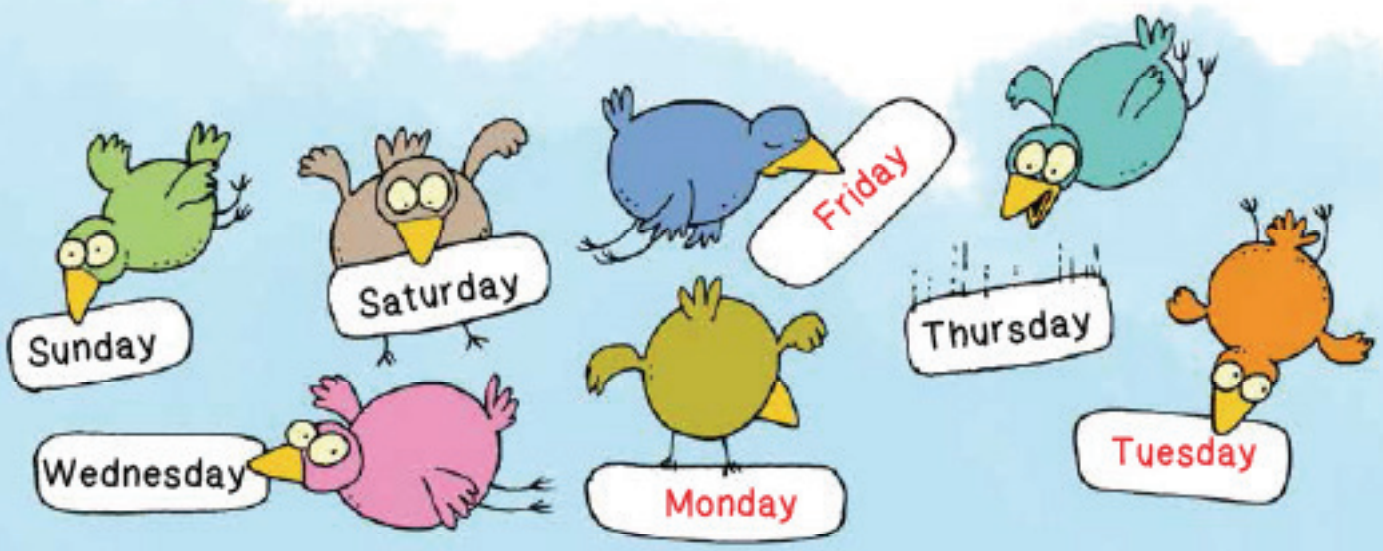



- 1 Jessica has got volleyball practice on Monday.
- 2 Susan has got a ballet class on Tuesday.
- 3 Elliot has got Science Club on Wednesday.
- 4 Ms Springfield has got a singing class on Thursday.
- 5 Greg has got a swimming class on Friday.
- 6 Luke has got ice hockey practice on Saturday.
- 7 It's picnic time for Uncle Phil on Sunday!

2  What's missing?



3   Tick the days and complete the sentences. **Students' answers.**

MY WEEK	Monday	Tuesday	Wednesday	Thursday	Friday	Saturday	Sunday
 a swimming class							
 a ballet class							
 football practice							
 tennis practice							
 basketball practice							
 a singing class							
 a piano class							

I've got _____ on _____.

_____ on _____.

_____ on _____.

4  **Students' answers.**

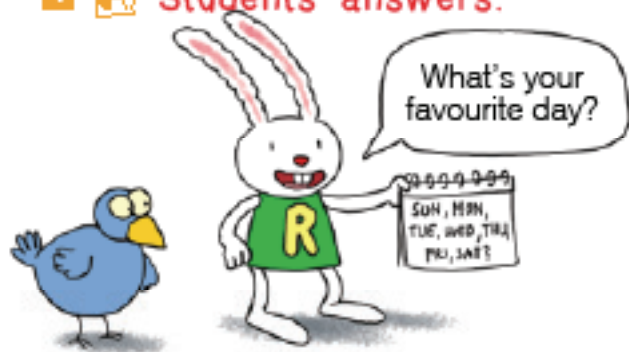

5  Complete the sentences.

five o'clock

seven o'clock

two o'clock

half past five

six o'clock

half past seven

half past six

It's five o'clock.
Time for my volleyball practice.



It's six o'clock.
Time for my Science Club.



It's half past seven.
Time for my ice hockey practice.



It's half past five.
Time for my ballet class.



It's half past six.
Time for my singing class.



It's seven o'clock.
Time for my swimming class.



It's two o'clock.
Picnic time!



6  Draw.

Hickory dickory dock.
What's the time?



1 It's half past ten.



2 It's half past two.



3 It's half past eight.



4 It's eleven o'clock.



5 It's four o'clock.



6 It's twelve o'clock.

7  Match.

1 It's two o'clock.	Luke is playing ice hockey.
2 It's five o'clock.	Susan is dancing.
3 It's half past five.	Greg is swimming.
4 It's six o'clock.	Ms Springfield is singing.
5 It's half past six.	Jessica is playing volleyball.
6 It's seven o'clock.	Uncle Phil is having a picnic.
7 It's half past seven.	Elliot is doing experiments.

8  Complete the sentences.

Robbie is a real friend, isn't he? 

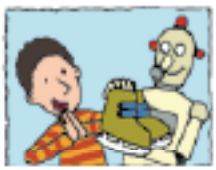

1 Robbie has got a pair of new **skates** for Luke because he can **play** ice hockey.

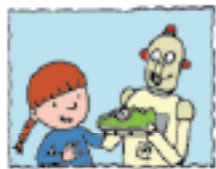

2 Robbie has got new **trainers** for Jessica because she can **play** volleyball.

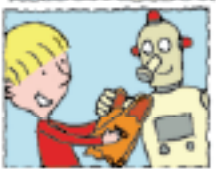

3 Robbie has got new **flippers** for Greg because he can **swim** very fast.



4 Robbie has got a new **book** for Elliot because he can **read** two books in a day.

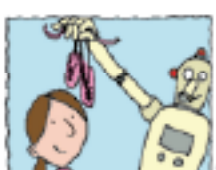

5 Robbie has got new **ballet shoes** for Susan because she can **dance** ballet.

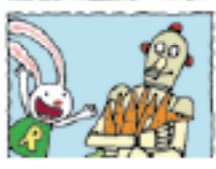

6 Robbie has got a lot of **carrots** for Ronnie because he can **eat** ten carrots in a minute.

trainers ~~skates~~
 flippers ~~carrots~~
 ballet shoes book

eat
 dance read
~~play~~ swim
 play

SUPER SUZY IS BACK!

1   Read and stick.

1 It's **eight o'clock** in the morning. Super Suzy is driving through the **desert**.

The camel is very thirsty, but Super Suzy has got a box full of **orange juice**.

2 It's **twelve o'clock** Super Suzy is in the **jungle** now.

The baby jaguar is in trouble. Super Suzy is climbing the tree to help him.

3 It's **five o'clock** in the afternoon. It's snowing and it's very cold in the Arctic.

Pixy is crying. Super Suzy is flying to the Arctic to help him.

4 It's **eight o'clock** in the evening. Super Suzy is very tired. She is drinking her favourite

super milk

2  Now listen and check.

3  Write about Super Sam. **Students' answers.**

It's  Super Sam is _____.

It's  Super Sam is _____.

It's  Super Sam is _____.

It's  Super Sam is _____.

It's  Super Sam is _____.



- riding a motorbike
- flying a helicopter
- driving a jeep
- roller-skating
- skiing
- eating spinach for lunch
- bringing super milk for Suzy
- bungee jumping

4 Write about your day. **Students' answers.**

Tell me about your day!



It's _____.

I'm _____.



It's _____.

I'm _____.



It's _____.

I'm _____.



It's _____.

I'm _____.



It's _____.

I'm _____.



It's _____.

I'm _____.

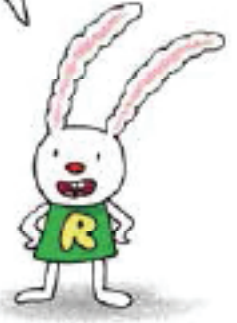

eating a sandwich

going to school

having dinner

doing homework

playing football

riding a bike

roller-skating

watching TV

having breakfast

sleeping

having lunch

brushing my teeth

A SILLY WEEK

1  What's the weather like? Circle the correct answers.

It's a) sunny.

b) windy.

c) hot.



It's a) foggy.

b) rainy.

c) cold.

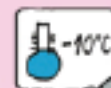

It's a) snowing.

b) rainy.

c) foggy.



It's a) windy.

b) rainy.

c) foggy.



It's a) snowing.

b) foggy.

c) windy.



It's a) hot.

b) sunny.

c) cold.



It's a) cold.

b) rainy.

c) snowing.



2  Do you remember the song *A Silly Week*? Complete the sentences.

cold

hot

rainy

windy

snowing

~~sunny~~

foggy

1 It's sunny on Monday.

4 It's foggy on Thursday.

2 It's hot on Tuesday.

5 It's windy on Friday.

3 It's rainy on Wednesday.

6 It's cold on Saturday.

7 It's snowing on Sunday.

3  Look at **Task 2** and find the right pairs.

5 Fly a kite!

What about Sunday?

3 Sing in the rain!



1 Take off your coat!

4 Don't fly a plane!

6 Let's skate tonight!

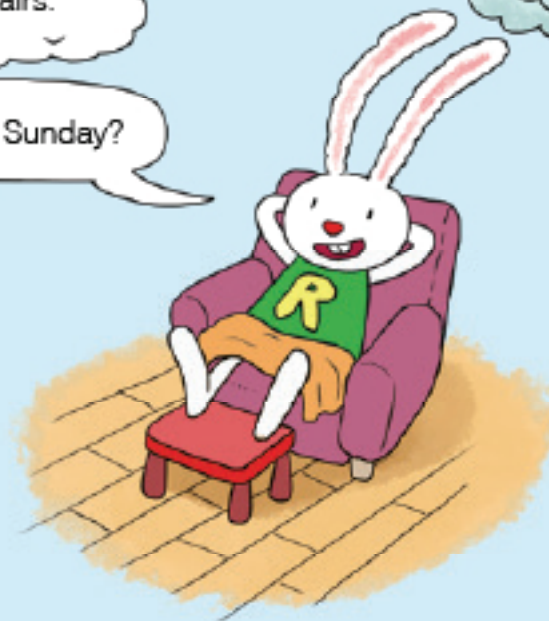
2 Let's row a boat!



4   What's the weather like today? **Students' answers.**

It's _____.

LET'S CHECK!

1 Fill in the missing letters. Then put the days in the right order.

5 THURSD A Y

2 M O NDAY

4 WE D NESDAY

1 S U NDAY

6 FR I DAY

3 TUE S DAY

7 SA T URDAY

T

A

S

D

O

~~U~~

I

2 Copy the words next to the right sentences.

picnic time

~~volleyball practice~~

swimming class

ice hockey practice

ballet class

singing class

Science Club

1 Jessica has got on Monday.	volleyball practice
2 Susan has got a on Tuesday.	ballet class
3 Elliot has got on Wednesday.	Science Club
4 Ms Springfield has got a on Thursday.	singing class
5 Greg has got a on Friday.	swimming class
6 Luke has got on Saturday.	ice hockey practice
7 It's for Uncle Phil on Sunday!	picnic time

3 Cross out the mistakes. Then write the correct sentences.

1 Super Suzy is ~~swimming~~ through the desert.
 Super Suzy is driving through the desert.

2 Super Suzy is driving to the Arctic.
Super Suzy is flying to the Arctic

3 Super Suzy is climbing the wall to help the baby jaguar.
Super Suzy is climbing the tree to help the baby jaguar

4  Match.



4 It's windy.

3 It's snowing.

2 It's sunny.

1 It's foggy.



2 It's five o'clock.

3 It's half past five.

1 It's half past ten.

5  Circle the odd one out.

1 Robbie can play	basketball	football	tennis	<u>volleyball.</u>
2 Robbie can play	<u>ice hockey</u>	the drums	the violin	chess.
3 Robbie can make	some tea	a mess	<u>a pizza</u>	pancakes.
4 Robbie can	read a book	<u>drive a car</u>	ride a bike	wash the dishes.

6  Draw your own questions for the BOARD GAME. **Students' answers.**

What's the time?	What's the weather like?
What can Robbie do?	What is Super Suzy doing?

GUESS THE MONTHS!

1  Write the names of the months.

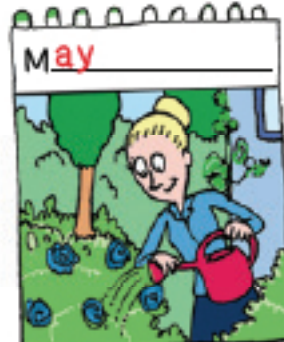

2   Look at the pictures in **Task 1** and tick the right answers.

1 It's January. Is Ronnie skiing?

- Yes, he is.
 No, he isn't.

7 It's July. Is Susan in a summer camp?

- Yes, she is.
 No, she isn't.

2 It's February. Is Super Sam decorating the Christmas tree?

- Yes, he is.
 No, he isn't.

8 It's August. Is Greg making sandcastles?

- Yes, he is.
 No, he isn't.

3 It's March. Is Jessica getting ready for Halloween?

- Yes, she is.
 No, she isn't.

9 It's September. Is school over?

- Yes, it is.
 No, it isn't.

4 It's April. Is the Easter Bunny preparing his Easter basket?

- Yes, he is.
 No, he isn't.

10 It's October. Is Elliot writing a Valentine card?

- Yes, he is.
 No, he isn't.

5 It's May. Is Ms Springfield watering her blue roses?

- Yes, she is.
 No, she isn't.

11 It's November. Is Luke listening to music?

- Yes, he is.
 No, he isn't.

6 It's June. Is it back-to-school time?

- Yes, it is.
 No, it isn't.

12 It's December. Is Uncle Phil picking snowdrops?

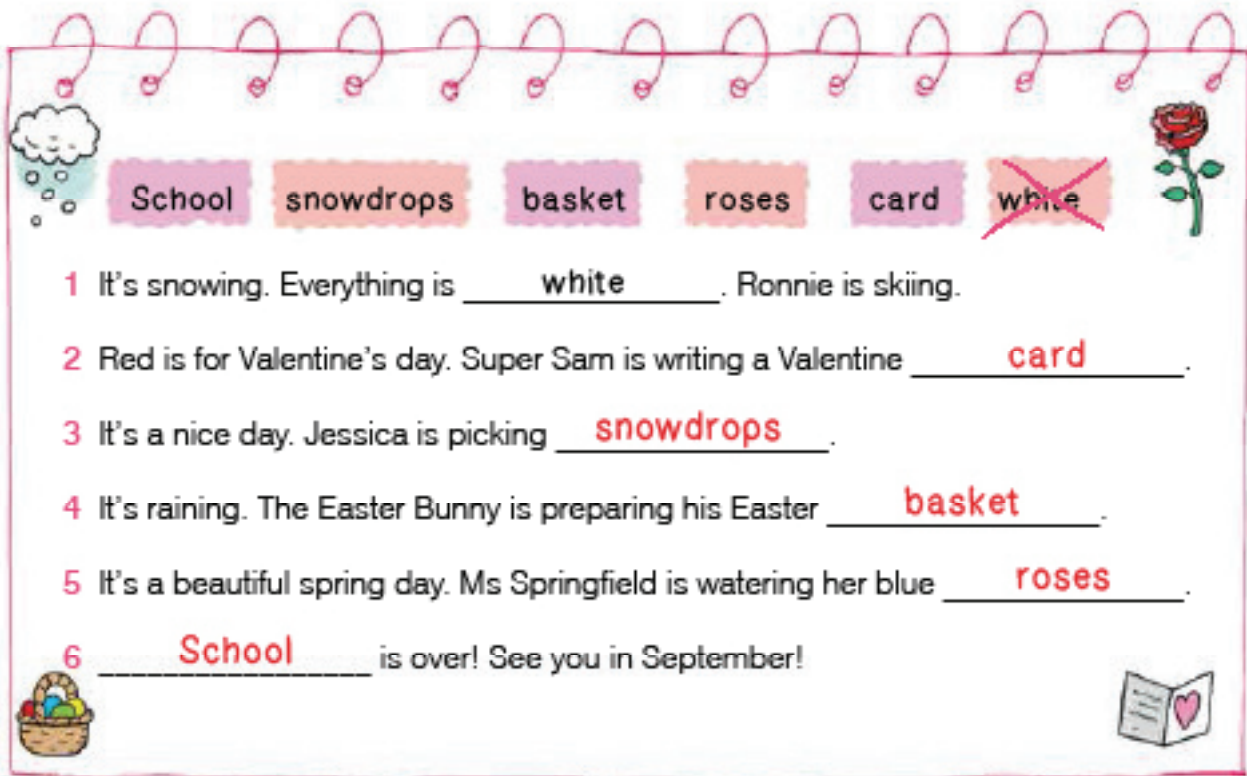

- Yes, he is.
 No, he isn't.

3  Complete the sentences.



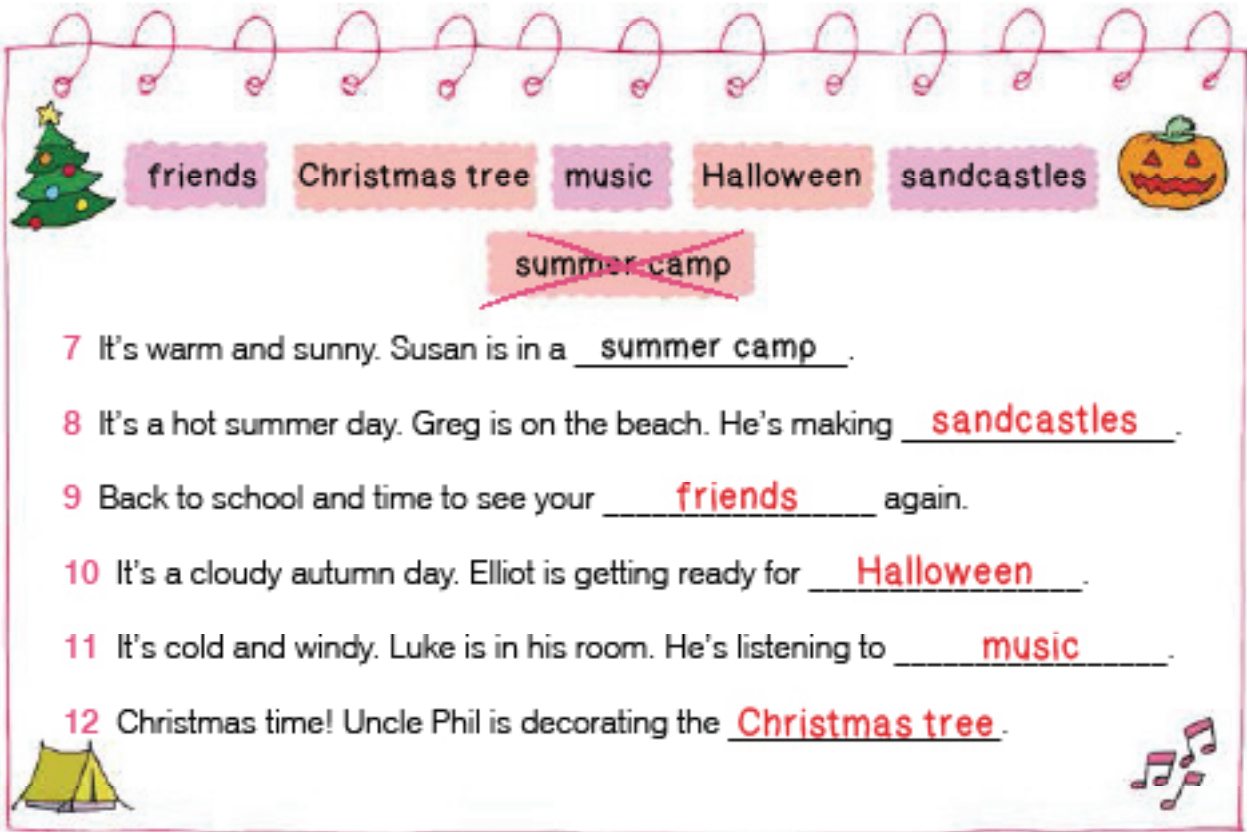

School snowdrops basket roses card ~~white~~

- 1 It's snowing. Everything is white. Ronnie is skiing.
- 2 Red is for Valentine's day. Super Sam is writing a Valentine card.
- 3 It's a nice day. Jessica is picking snowdrops.
- 4 It's raining. The Easter Bunny is preparing his Easter basket.
- 5 It's a beautiful spring day. Ms Springfield is watering her blue roses.
- 6 School is over! See you in September!

friends Christmas tree music Halloween sandcastles ~~summer camp~~

- 7 It's warm and sunny. Susan is in a summer camp.
- 8 It's a hot summer day. Greg is on the beach. He's making sandcastles.
- 9 Back to school and time to see your friends again.
- 10 It's a cloudy autumn day. Elliot is getting ready for Halloween.
- 11 It's cold and windy. Luke is in his room. He's listening to music.
- 12 Christmas time! Uncle Phil is decorating the Christmas tree.

4  Answer the questions.



More questions...

- 1 Who is getting ready for Halloween?
- 2 What's the weather like in April?
- 3 When is Valentine's Day?
- 4 It's January. What is Ronnie doing?
- 5 It's August. Where is Greg?
- 6 Who is decorating the Christmas tree?

Elliot

It's raining



In February

He is skiing

On the beach

Uncle Phil.

5  Now listen and check.

6   Draw and write. **Students' answers.**

MY FAVOURITE MONTH

My favourite month is _____.

WHAT'S YOUR FAVOURITE SEASON?

1 Write: **is** or **can**.

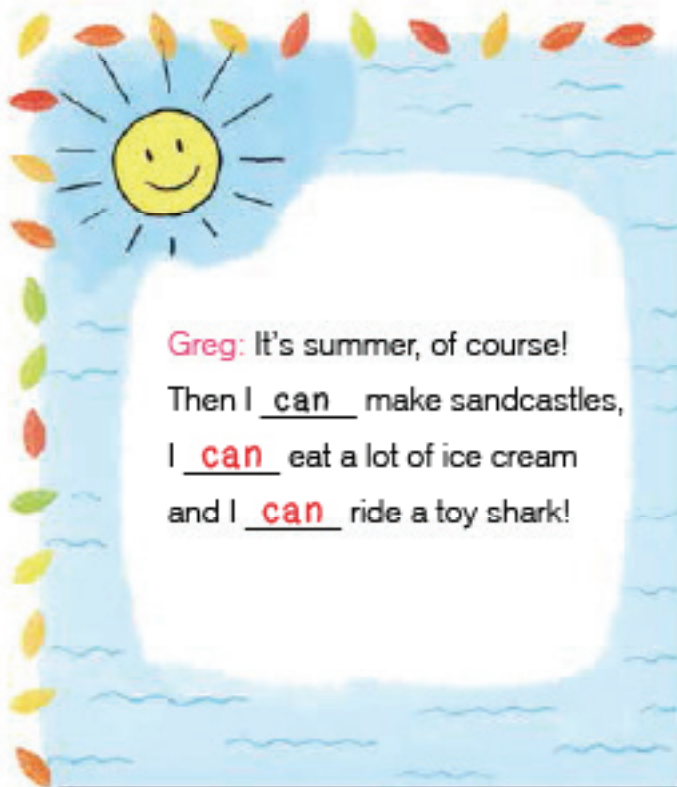

Greg: It's summer, of course!
Then I can make sandcastles,
I can eat a lot of ice cream
and I can ride a toy shark!

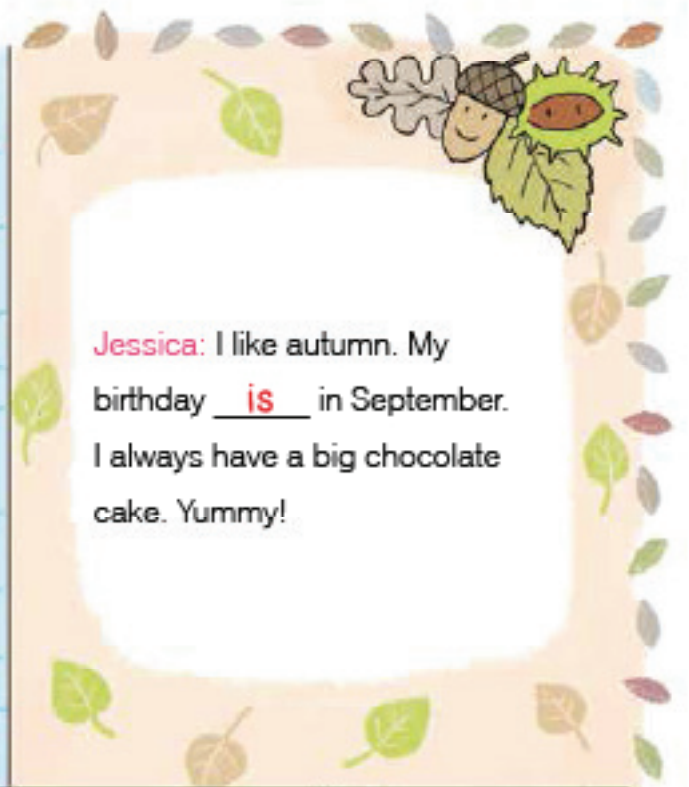

Jessica: I like autumn. My
birthday is in September.
I always have a big chocolate
cake. Yummy!



Luke: My favourite season
is winter. I like snow, winter
sports and presents from Santa.



Ms Springfield: My garden
is very beautiful in spring.
Birds are singing and there
are flowers everywhere. Spring
is so romantic, isn't it?



2  Help Ronnie match the sentences. Then write them.

- 1 I like summer because then I can swim in the sea.
- 2 I like autumn because then I can put on my Halloween costume.
- 3 I like winter because then I can make a snowman.
- 4 I like spring because then I can see my friend Easter Bunny.

3  Draw Ronnie in different seasons. **Students' answers.**

 SUMMER	 AUTUMN	 WINTER	 SPRING



4   Draw and write. **Students' answers.**



My favourite season is _____ because then

I can _____.

5  Complete Jessica's birthday list.



~~Greg - Feb~~

Luke - Dec

Susan - Aug

Elliot - Oct

Kim - Sept

Greg's birthday is in February.

Luke's birthday is in December.

Susan's birthday is in August.

Elliot's birthday is in October.

Kim's birthday is in September.

6  What about you? **Students' answers.**

My birthday is in _____.

My mum's birthday is in _____.

My dad's birthday is in _____.

My brother's birthday is in _____.

My sister's birthday is in _____.

My best friend's birthday is in _____.

My teacher's birthday is in _____.



THE FOX AND THE HEDGEHOG

1  Put the sentences in the right order.



- 1 It's spring. The hedgehog is cleaning his house.
- 4 It's winter. The hedgehog is sitting in his armchair.
- 3 It's autumn. The hedgehog is carrying a basket full of apples.
- 2 It's summer. The hedgehog is carrying a basket full of twigs.
- 5 The hedgehog has got some food, a drink and a warm blanket.



- 2 The fox is sitting under the tree and drinking lemonade.
- 3 The fox is snoring.
- 1 The fox is looking at himself in the mirror.
- 4 The fox is knocking on the door.
- 5 The fox is freezing.

2  Now listen and check.

3  Work in pairs and tell the story.

4  Circle the correct answer.

1



It's spring.

The hedgehog is is not cleaning his house.

2



It's summer.

The hedgehog is is not drinking lemonade.

3

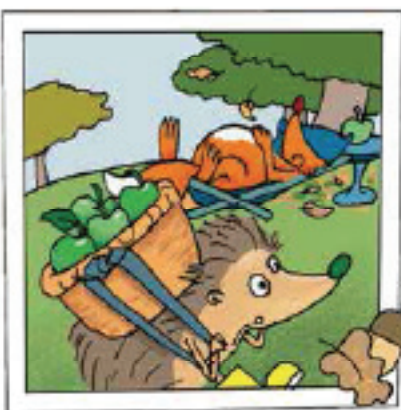

It's autumn.

The hedgehog is is not carrying a basket full of apples.

4



It's winter.

The hedgehog is is not freezing.

5  Write: **Yes, he is.** or **No, he isn't.**

1 It's spring. Is the fox looking at himself in the mirror?

Yes, he is.

2 It's summer. Is the fox carrying a basket full of twigs?

No, he isn't.

3 It's autumn. Is the fox snoring?

Yes, he is.

4 It's winter. Is the fox sitting in his armchair?

No, he isn't.

6  **Draw. Students' answers.**

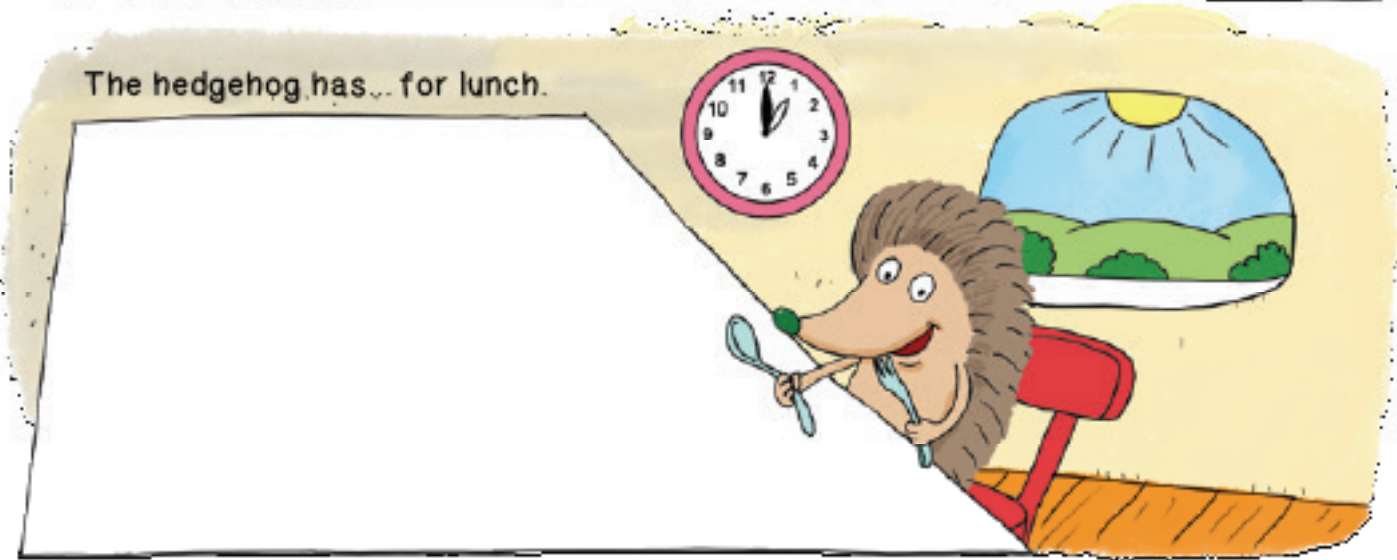
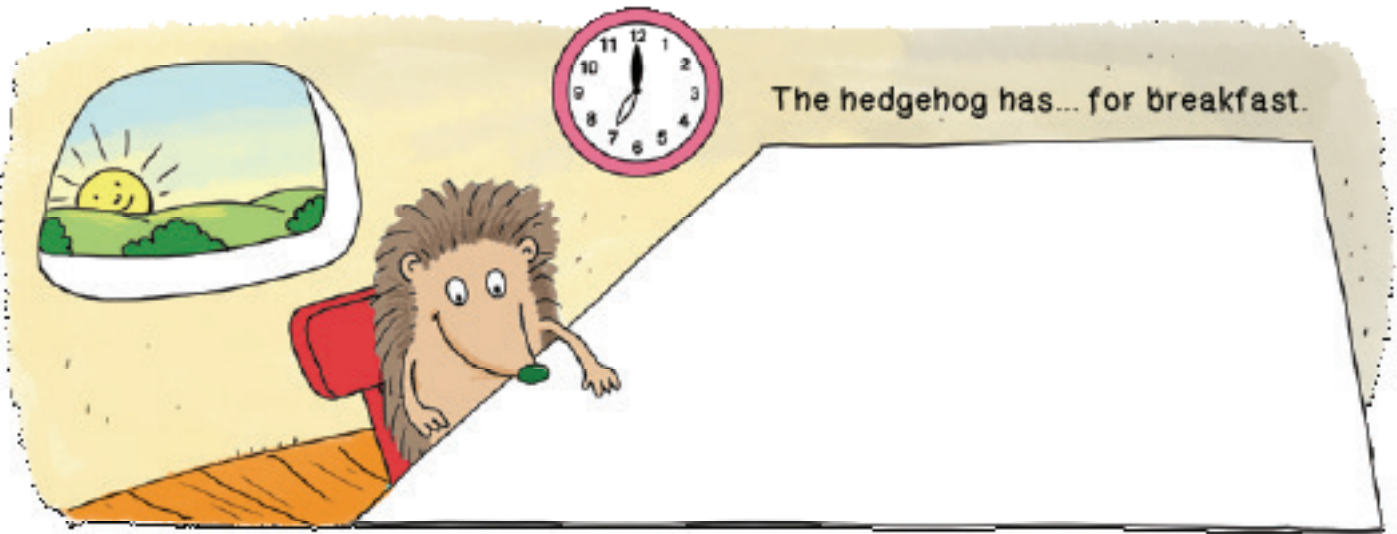

7  Draw.

Students' answers.

What do you have for breakfast, lunch and dinner?

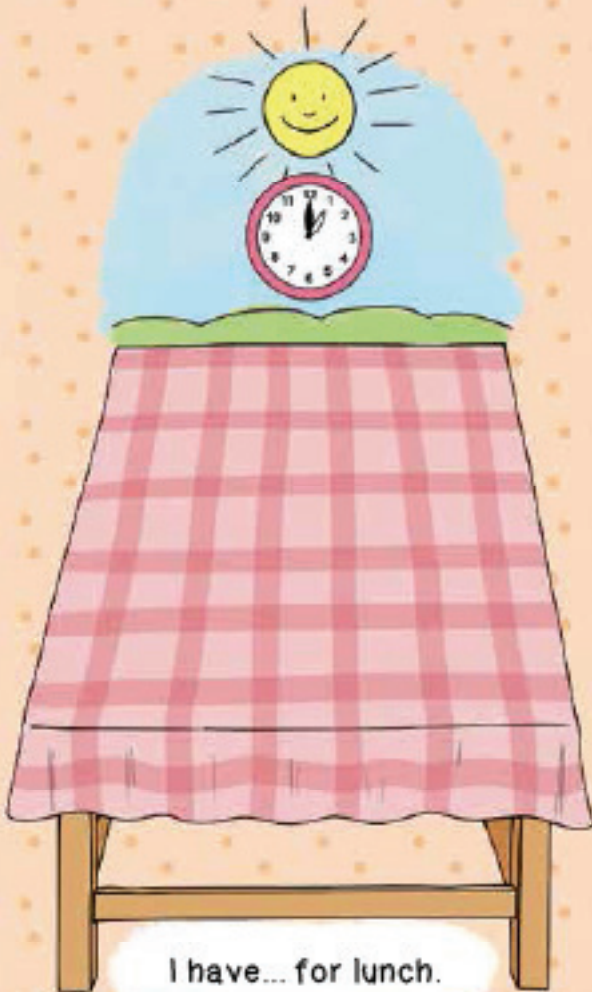

ITSY BITSY SPIDER

1  Match.

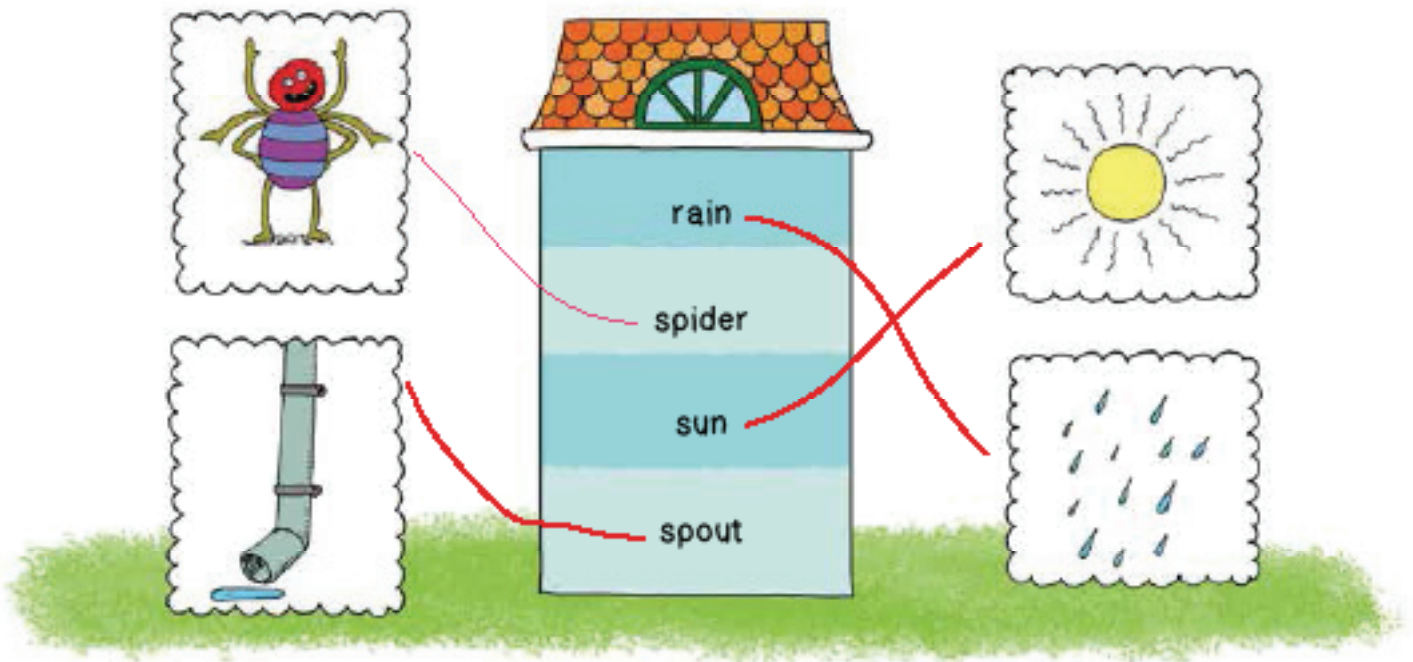

2  Read the song.

An itsy bitsy  climbed up the water .

Down came the  and washed the  out.

Out came the  and dried up all the .



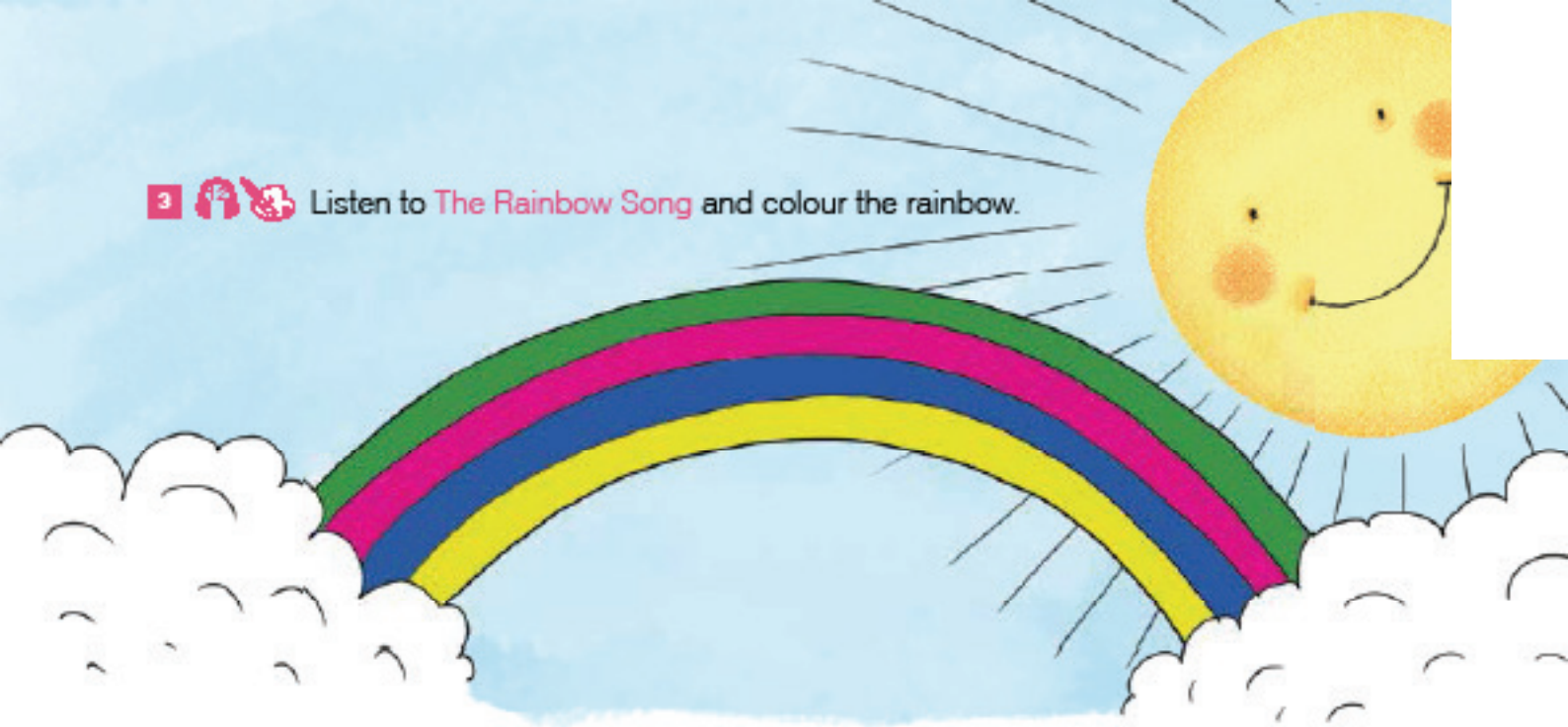

An itsy bitsy  climbed up the  again.

3   Listen to **The Rainbow Song** and colour the rainbow.



4   Listen and sing.

5  Draw. **Students' answers.**

	
It's cold and windy.	It's warm and sunny.
	
It's raining.	It's snowing.

LET'S CHECK!

1  Unscramble the letters and fill in the missing numbers.



AMRCH

MARCH 3



AUGSTU

AUGUST 8



RUARYFEB

FEBRUARY 2



PRILA

APRIL 4



BERDECME

DECEMBER 12



YAM

MAY 5



UNEJ

JUNE 6



ARYJANU

JANUARY 1

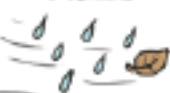

EMBNOVER

NOVEMBER 11



TEMSEPBER

SEPTEMBER 9



OBEROCT

OCTOBER 10



JUYL

JULY 7

2  Write.



winter



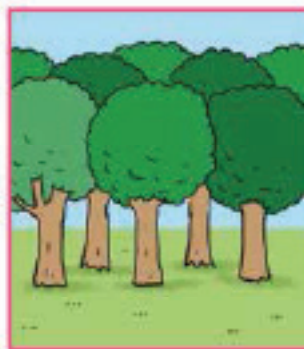

spring



summer



autumn

- 3   Circle the correct answers.
Then write one more question.

Can you make
your own questions?



- 1 Is Christmas in December?
- 2 Is Valentine's Day in February?
- 3 Is Jessica's birthday in March?
- 4 _____?

Yes, it is. / No, it isn't.
Yes, it is. / No, it isn't.
Yes, it is. / No, it isn't.

- 1 You can ski in winter.
- 2 You can swim in the sea in autumn.
- 3 You can make a snowman in summer.
- 4 _____.

YES / NO
YES / NO
YES / NO

- 4   Match and write.

- 1 It's March. What is Jessica doing?
- 2 It's August. Where is Greg?
- 3 What's the weather like in summer?
- 4 Who is preparing his Easter basket?
- 5 When is Halloween?
- 6 _____?

- 3 It's hot and sunny.
- 4 The Easter Bunny.
- 1 She is picking snow drops.
- 5 In October.
- 3 On the beach.

ELLIOT'S HOUSE

1  Write and colour.

April's room

Elliot's room

a kitchen

a hall



a dining room

a bathroom

a bedroom

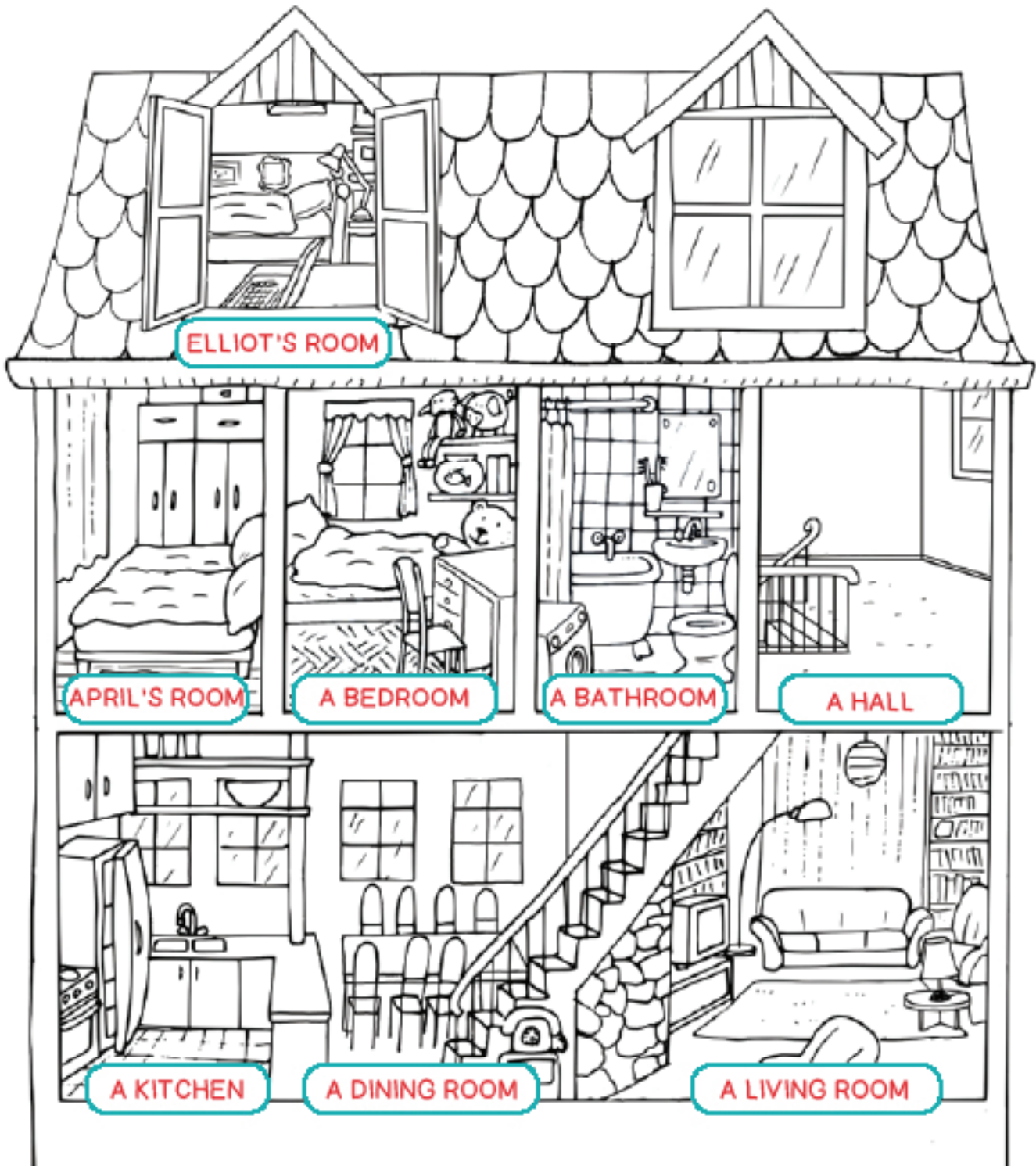
a living room



2   Listen and draw the animals.



3  Complete the sentences.

- 1 There is a spider in the bathroom.
- 2 There is a cat in the bedroom.
- 3 There is a mouse in the kitchen.
- 4 There is a rabbit in the garden.
- 5 There is a frog in April's room.
- 6 There is a snake in the hall.
- 7 There is a fish in the living room.
- 8 There is a butterfly in Elliot's room.

butterfly

cat

~~spider~~

frog

snake

rabbit

fish

mouse

WHERE IS GIZMO?

1  Help Kim. Fill in the missing letters.



1 a fridge



2 a sofa



3 a cooker



4 a bath



5 a toilet



6 a dishwasher





7 a sink

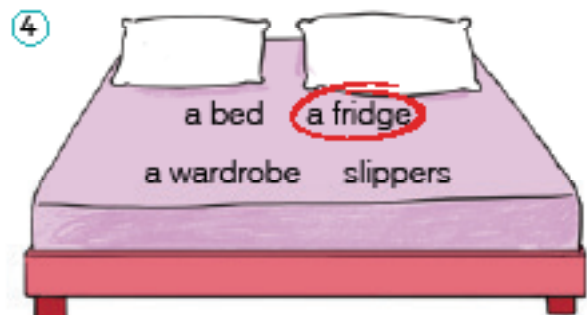
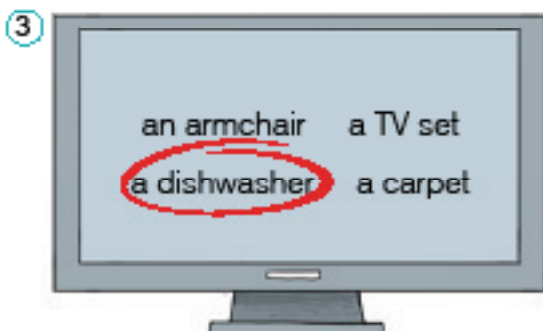
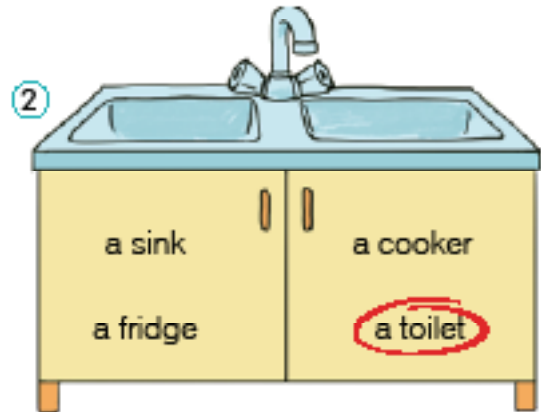
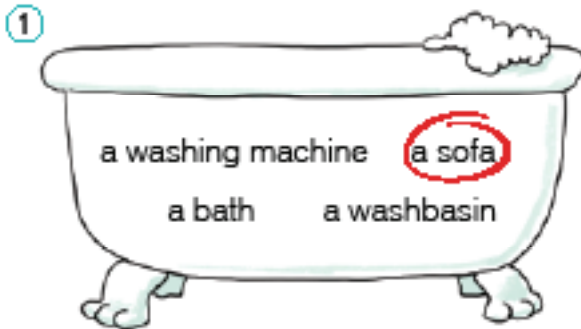

8 a washbasin

2  What's wrong? Circle the odd one out.



3  Complete the sentences.

1 In this room there is a fridge,
a cooker, a sink and
a dishwasher. I like pancakes!



2 In this room there is a sofa,
a carpet, an a armchair
and a TV set. I like watching TV!



3 In this room there is a bath,
a washing machine,
a washbasin and
a toilet. I like bubbles!



4 In this room there is a big bed
and a wardrobe. There are my
mum's slippers, too. I like stories!



4  Match.

1 There is a cooker...

2 There are slippers...

3 There is a washing machine...

4 There is a TV set...

5 There are a lot of toys...

6 There are two chairs...

in the bathroom.

in the living room.

in the kitchen.

in the dining room.

in Kim's room.

in the bedroom.

5 Write: **in**, **on**, **under**, **behind** or **in front of**.

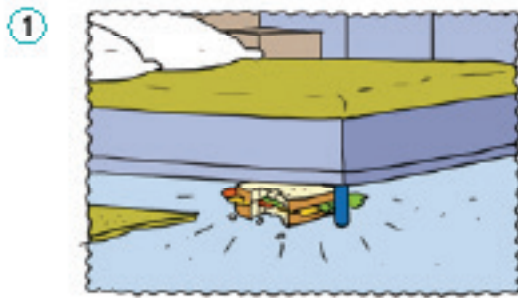

There is a sandwich **under** the bed.

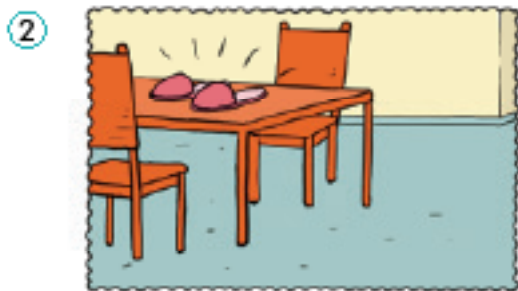

There are slippers **on** the table.



There is a mess **in front of** the TV.



There is a book **in** the bath.

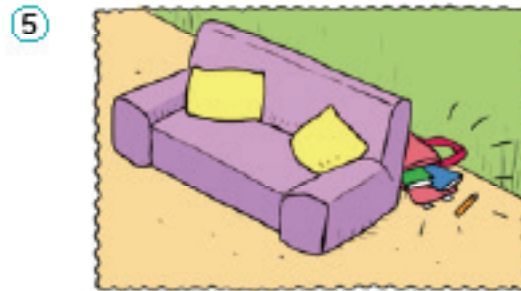

There is a schoolbag **behind** the sofa.

6 Complete the sentences.



teddy bear

toybox

doll

books

Gizmo

- There is a **doll** on the floor.
- There are three **books** under the desk.
- There is a **teddy bear** behind the computer.
- There is a **toybox** in front of the wardrobe.
- There is **Gizmo** in the toybox.

7 Now listen and check.

8  Circle the correct answers.

What about your room?

Students' answers.

1 Is there a computer in your room?

Yes, there is. / No, there isn't.

2 Is there a desk in your room?

Yes, there is. / No, there isn't.

3 Are there a lot of books in your room?

Yes, there are. / No, there aren't.

4 Are there a lot of toys in your room?

Yes, there are. / No, there aren't.

5 Is there a TV set in your room?

Yes, there is. / No, there isn't.

What else is there in your room?

9  Read and draw.

1



There is a carrot in the fridge.

2

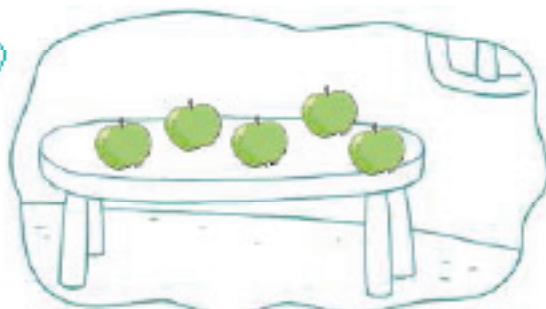

There are five apples on the table.

3



There are two socks in the washing machine.

4



There is a book under the bed.

5



There is a mouse behind the sofa.

6



There is a hedgehog in front of the door.

10  Look at **Task 9** again. Listen and correct the mistakes.

HOME SWEET HOME

1 Write and draw. **Students' answers.**

hole

~~nest~~

house

flat

hive

1 A robin lives in
a nest.



3 A bunny lives in
a hole.



2 A bee lives in
a hive.



4 I live in
a house/flat.



2 Circle the correct answers.

 1
The house is a) happy.
 b) scared.

 4
The house is a) hungry.
 b) hot.

 2
The house is a) cold.
 b) tired.

 5
The house is a) dirty.
 b) thirsty.

 3
The house is a) sad.
 b) sleepy.

3  Complete the dialogues.

1 

Greg: The house is cold.
Jessica: Light the fireplace.

Open the windows.

Clean it.

Turn off the lights.

Turn on the lights.

~~Light the fireplace.~~

2 

Kim: The house is sleepy.
Susan: Turn off the lights.

3 



Ronnie: The house is hot.
Uncle Phil: Open the windows.

4 

Elliot: The house is dirty.
April: Clean it.

5 

Greg: The house is scared.
Robbie: Turn on the lights.

4   The house is sad. Help the house!
Students' answers.

I'm so sad. I'm not beautiful.



A MAGIC MESS

1  Stick.

2  Speak about Elliot's house.



What's there in Elliot's house?

Elliot's room

a bedroom



April's room



a bathroom



a hall



a kitchen

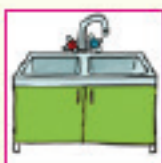

a dining room



a living room

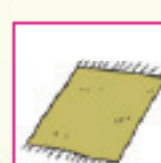

LET'S CHECK!

1 Find 16 words in the wordsnake.



2 Sort out the words from the wordsnake. Find the **odd one out!**

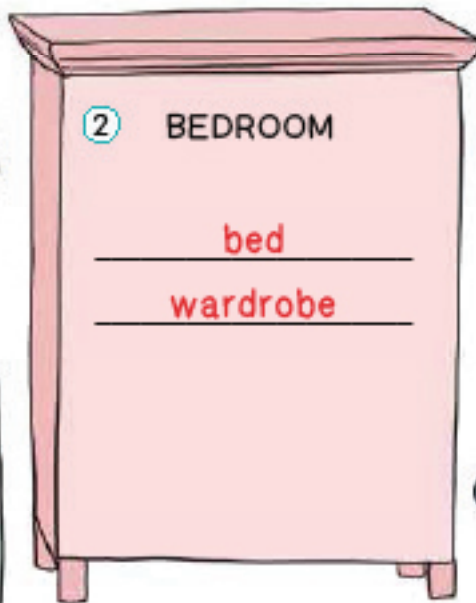
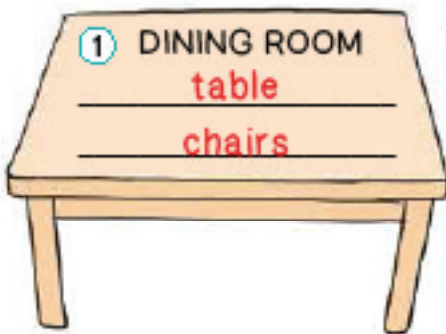

odd one out - desk

3 Match.



- 1 There are seven little beds...
- 2 There are seven pairs of shoes...
- 3 There are seven apples...
- 4 There are seven toothbrushes...
- 5 There are seven little chairs...
- 6 There are seven photos...



- 4 in the bathroom.
- 2 in the hall.
- 5 in the dining room.
- 3 in the kitchen.
- 6 in the living room.
- 1 in the bedroom.

4 Look at the picture in Task 3 and write the answers.

- 1 Where is the frog? On the bed.
- 2 Where is the squirrel? Behind the sofa.
- 3 Where is the owl? On the roof.
- 4 Where is the mouse? In a shoe.
- 5 Where is the bird? On the fridge.
- 6 Where is the rabbit? Under the table.

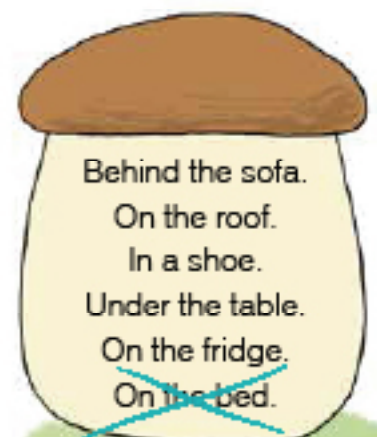

ROBBIE'S FRIEND

1  Write correct sentences about Ruby.



is

has got

lives

likes

can

in Roboland.

fix your TV set.

very clever.

orange hair and green eyes.

travelling in space.

fix your computer.

pretty.

- 1 Ruby lives in Roboland.
- 2 Ruby has got orange hair and green eyes
- 3 Ruby is pretty
- 4 Ruby is very clever
- 5 Ruby can fix your TV set
- 6 Ruby can fix your computer
- 7 Ruby likes travelling in space

2  Complete the sentences. Write: **is**, **has got** or **can**.

This is my friend Ruby. She lives in Roboland. She is very young. She is only 50. Her birthday is in February.

She has got orange hair and green eyes.

She is wearing a space jacket. She is very pretty, isn't she?

Ruby is very clever. She can solve ten maths riddles in five minutes. But that's not all. She can fix your TV set, she can fix your computer and she can fix her own spaceship, too.

She likes travelling in space. My friend Ruby is great!



3  Write about your friend. **Students' answers.**



This is my friend _____
 He lives in _____
 He is _____
 His birthday is in _____
 He has got _____ and _____
 He can _____
 He likes _____



This is my friend _____
 She lives in _____
 She is _____
 Her birthday is in _____
 She has got _____ and _____
 She can _____
 She likes _____



blue eyes
 brown eyes
 green eyes
 blonde hair
 brown hair
 long hair
 ginger hair

music school
 tennis football
 basketball
 summer winter
 ice cream
 pizza

January February
 March April
 May June
 July August
 September October
 November
 December

play the guitar
 play the piano
 play tennis
 play football
 ski
 skate
 swim

lazy
 young
 pretty clever
 strong romantic
 hard-working funny

THE BUILDING BLOCKS JEOPARDY

1   Read the questions in the Student's Book and write the correct answers.

STORIES	THE CALENDAR	THE HOUSE	THE ANIMAL WORLD	SCHOOL
1 A penguin.	1 It's sunny and hot.	1 The kitchen.	1 White.	1 On the wall.
2 Blue.	2 Sunday.	2 A washing machine.	2 In the desert.	2 A book.
3 He can swim.	3 December.	3 A wardrobe.	3 It can talk.	3 40, 50, 80, 100
4 You can light the fireplace.	4 Winter.	4 The living room.	4 A bear.	4 60.
5 She is climbing a tree.	5 It's 8 o'clock.	5 A chair.	5 ...funny. ...bananas. ...climb a tree.	5 24.

~~A penguin.~~
Blue.
Sunday.
On the wall.
...funny.
...bananas.
...climb a tree.
It can talk.
A book.

A bear.
White.
A wardrobe.
Winter.
24.
A chair.
The kitchen.
40, 50, 80, 100.
In the desert.

It's 8 o'clock.
The living room.
December.
It's sunny and hot.
He can swim.
She is climbing a tree.
A washing machine.
You can light the fireplace.
60.

2 Tick: YES or NO.

- | | YES | NO |
|--|-------------------------------------|-------------------------------------|
| 1 Pixy is a penguin. | <input checked="" type="checkbox"/> | <input type="checkbox"/> |
| 2 Harold the Hippo can climb a tree. | <input type="checkbox"/> | <input checked="" type="checkbox"/> |
| 3 It's picnic time. It's Monday. | <input type="checkbox"/> | <input checked="" type="checkbox"/> |
| 4 It's time to decorate your Christmas tree. It's December. | <input checked="" type="checkbox"/> | <input type="checkbox"/> |
| 5 It's snowing. Everything is white. It's summer. | <input type="checkbox"/> | <input checked="" type="checkbox"/> |
| 6 You can wash your clothes in a cooker. | <input type="checkbox"/> | <input checked="" type="checkbox"/> |
| 7 There is a cooker, a fridge and a dishwasher in the kitchen. | <input checked="" type="checkbox"/> | <input type="checkbox"/> |
| 8 A camel lives in the desert. | <input checked="" type="checkbox"/> | <input type="checkbox"/> |
| 9 A parrot can fly. | <input checked="" type="checkbox"/> | <input type="checkbox"/> |
| 10 There are 24 minutes in an hour. | <input type="checkbox"/> | <input checked="" type="checkbox"/> |



3 Correct the wrong sentences.

- 1 Harold the Hippo can swim.
- 2 It's picnic time. It's Sunday.
- 3 It's snowing. Everything is white. It's winter.
- 4 You can wash your clothes in a washing machine.
- 5 There are 60 minutes in an hour.



THE BUILDING BLOCKS FAREWELL PARTY

1  Complete the texts.

children pizza sitting ~~over~~ orange juice table

School is over. It's a nice day.

There are a lot of children in Ms Springfield's garden.

Uncle Phil is here, too. He is sitting in the chair and drinking orange juice. There is a big table in the garden with a lot of food and drinks. Look at Jessica! She is eating pizza.

~~kite~~ bike swinging ball dancing guitar tree kitchen sandwich singing

What are the others doing?

Greg is flying a kite, Luke is playing with a ball, Susan is riding a bike, and Elliot is climbing a tree. Be careful, Elliot! Pixy is playing the guitar and Ms Springfield is singing. What a lovely song! Kim and Gizmo are having fun, too. They are swinging.

There are two robots in the garden. What are they doing? They are dancing.

And where is Ronnie? In the kitchen, of course. He is making a sandwich.

Everybody is happy. Goodbye, children, and enjoy your summer holidays!

2  Now listen and check.

3  Circle the correct answer.

- 1 Ronnie is
 is not eating a sandwich.
- 2 Ms Springfield is
 is not singing.
- 3 Pixy is
 is not playing the piano.
- 4 Robbie and Ruby are
 are not dancing.
- 5 Uncle Phil is
 is not drinking milk.
- 6 Kim and Gizmo are
 are not swinging.



4  Circle the correct answer.

- 1 Is Elliot climbing a tree? Yes, he is. / No, he isn't.
- 2 Is Jessica eating an apple? Yes, she is. / No, she isn't.
- 3 Are Robbie and Ruby singing? Yes, they are. / No, they aren't.
- 4 Is Susan riding a bike? Yes, she is. / No, she isn't.
- 5 Is Greg playing with a ball? Yes, he is. / No, he isn't.
- 6 Are Kim and Gizmo dancing? Yes, they are. / No they aren't.



5  Play the game.



Let's play a game!

- A Complete the sentence.
- B Circle the correct answer.
- C Correct the mistake.
- D Put the words in the right order.

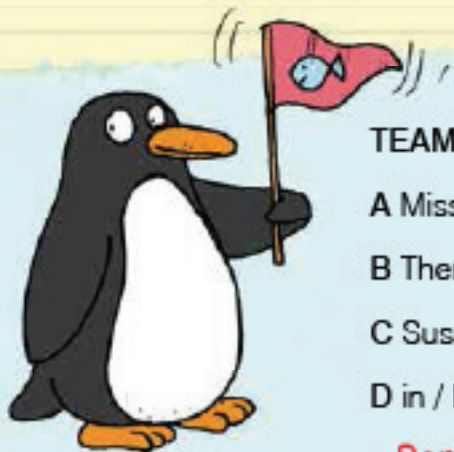

TEAM 1 PENGUINS

- A Miss Springfield has got blue eyes.
- B There is are a cake on the table.
- C Susan have got a blue bike. **has got**
- D in / Ronnie / the kitchen / is.
Ronnie is in the kitchen.

TEAM 2 GIRAFFES

- A Pixy is playing the guitar.
- B Look at Greg. His / her kite is yellow.
- C The bird is in the roof. **on**
- D Jessica / pizza / eating / is.
Jessica is eating pizza.



TEAM 3 MONKEYS

A There are three apples in the basket.

B The pizza is on under the table.

C Robbie and Ruby is dancing. **are**

D Susan / long hair / has got.

Susan has got long hair.



TEAM 4 PARROTS

A Kim and Gizmo are swinging.

B Ruby has got have got orange hair.

C Elliot aren't climbing a tree. **is**

D Greg / a red T-shirt / wearing / is.

Greg is wearing a red T-shirt.

TEAM 5 CAMELS

A The children are very happy.

B There is / are three sandwiches on the table.

C Look at Ruby! His skirt is pink. **Her**

D Three bananas / in the basket / there are.

There are three bananas in the basket.

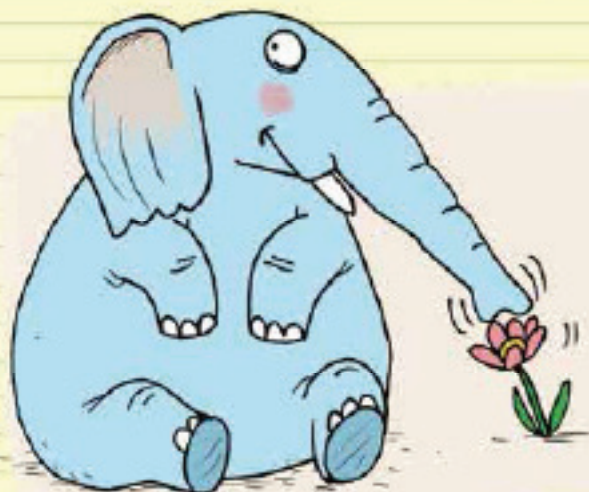

TEAM 6 ELEPHANTS

A Ronnie is very hungry.

B There are three banana / bananas in the basket.

C Uncle Phil is drink orange juice. **drinking**

D Luke / is / with a ball / playing.

Luke is playing with a ball.

THE HALLOWEEN SONG

1  Match.

1 a mask

2 cookies

3 a witch

4 a queen

5 a dress

6 a pumpkin

2  Unscramble the letters, then write the words.

sreds

iwthc

smak

eequn

1 d r e s s

2 w i t c h



3 m a s k

4 q u e e n



3  Stick.

It's Halloween,
it's Halloween,
Be a witch or
a queen!



Make some
cookies,
Something
sweet,



Can't you hear
trick or treat?



Light the
pumpkin,



Wear
a mask,



Put on your
party dress!

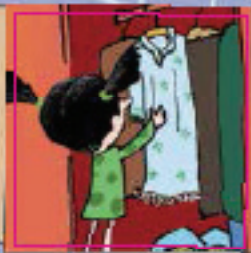

Be a witch
or a queen,
It's Halloween,
it's Halloween.



LETTERS TO SANTA CLAUS

1  Complete the sentences.

- 1 Greg would like a new computer game.
- 2 Kim would like a book about dogs.
- 3 Ronnie would like a carrot cake.
- 4 Elliot would like a new crystal ball.
- 5 Jessica would like a new umbrella.

2  Write your letter to Santa Claus.
Students' answers.

Dear Santa Claus,



I hope you're coming to my house on Christmas.

I would like _____.

Love,





3    Make your Christmas card.
Students' answers.

MERRY CHRISTMAS AND
A HAPPY NEW YEAR!
LOVE, _____



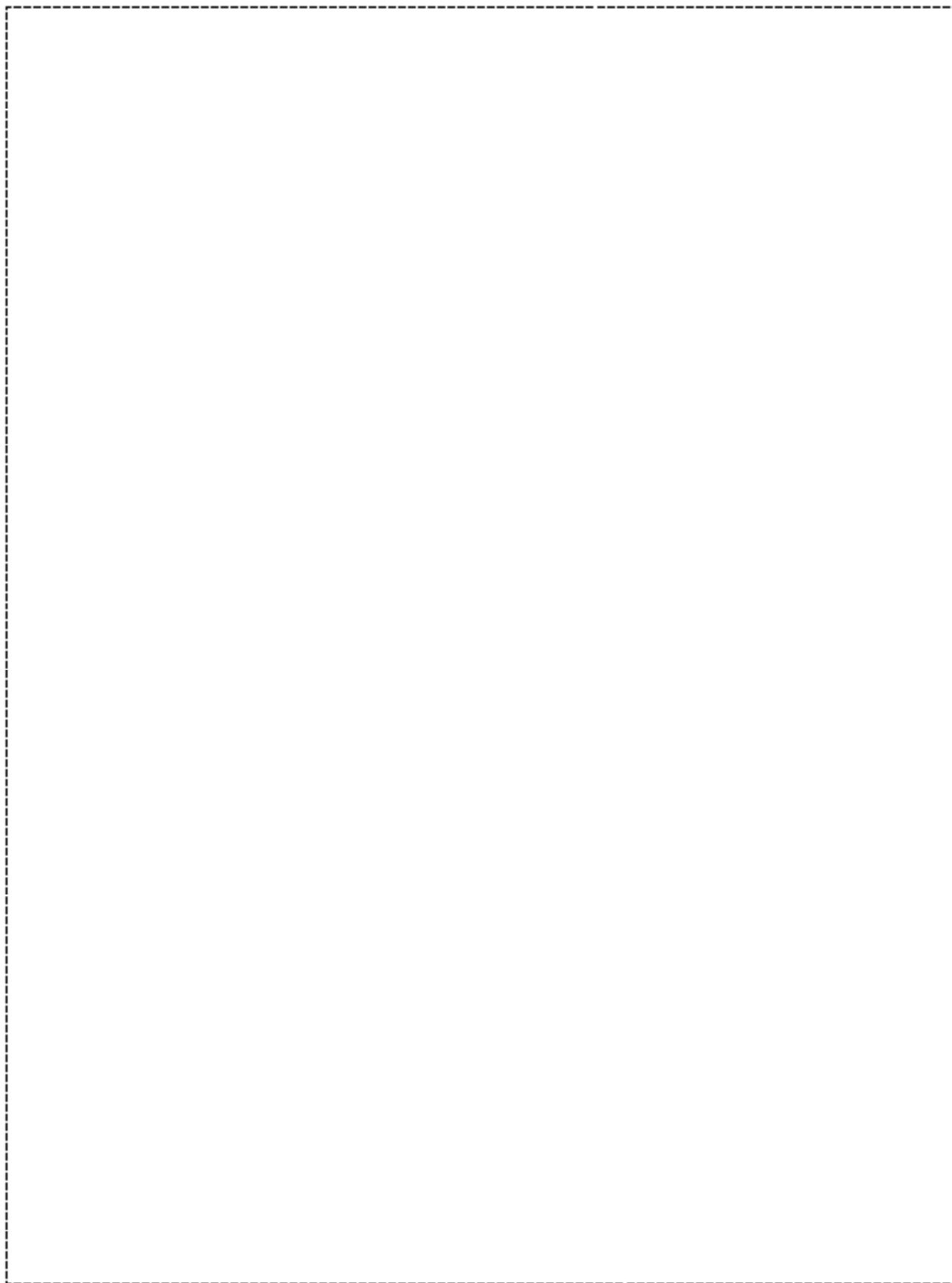

8

COUNTING VALENTINES

- 1  Ronnie is romantic. What has he got for his sweetheart? Trace and colour the picture.
Students' answers



- 2  Draw and write a Valentine card for someone you love. Students' answers

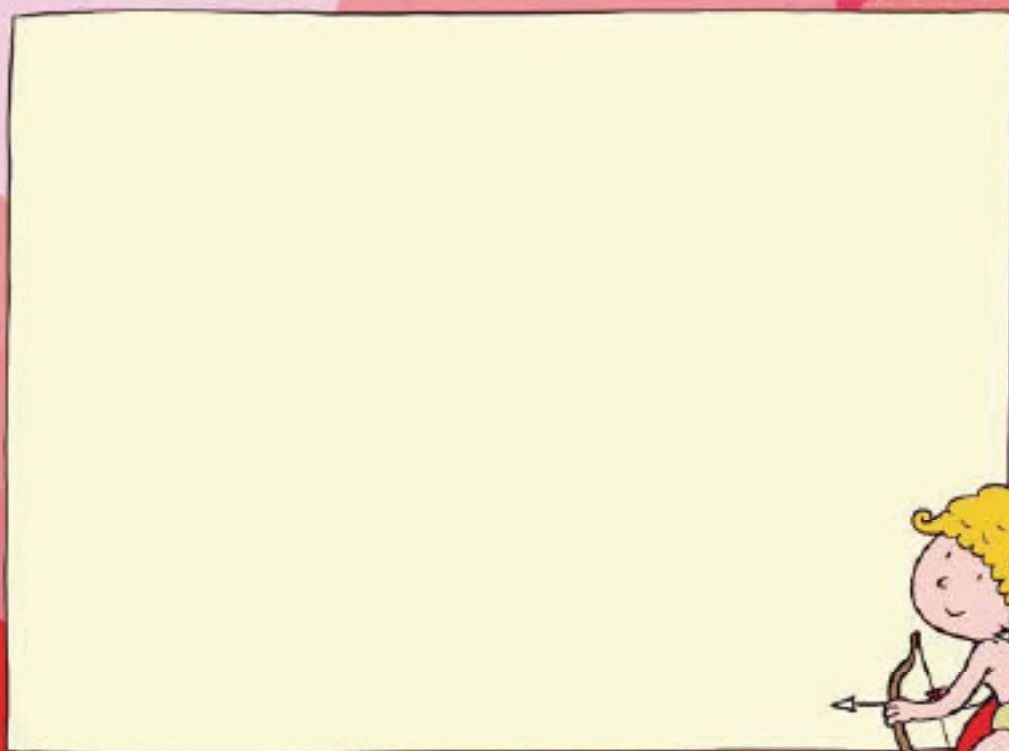

RONNIE'S EGG HUNT

1  Match.



2  Where are the eggs? Write: **in**, **on** or **under**.

1 There is a blue egg under the tree.

2 There is a red egg in the shoe.

3 There is a yellow egg in the basket.

4 There is a brown egg on the wardrobe.

5 There is a green egg under the desk.

6 There is an orange egg in the garden.

7 There is a pink egg under the fridge.

3  Draw your Easter egg. **Students' answers.**



UNIT 1 Lesson 4 Task 1

Have you got a dog or a cat?

Or a spider in the box?

Have you got a special pet?

A big green snake is here for you,

Funny monkey, clever fox,

Don't be scared,

It's friendly, too!

UNIT 2 Lesson 2 Task 2

a book

his car

a carrot

the piano

on the phone

UNIT 2 Lesson 2 Task 3

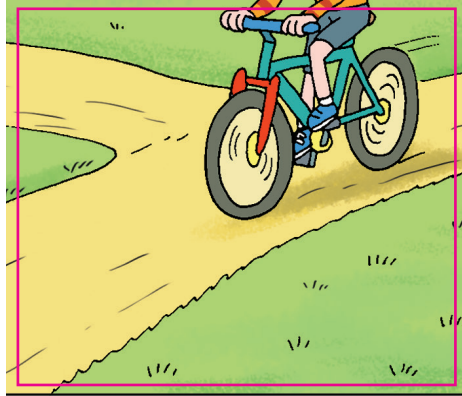
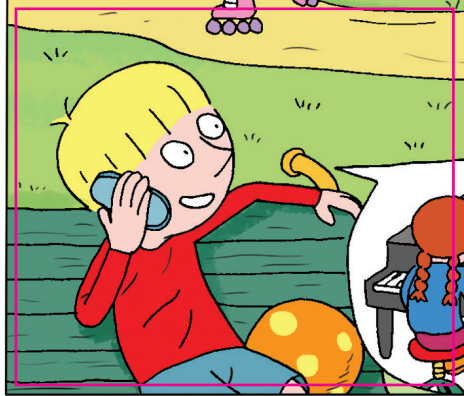
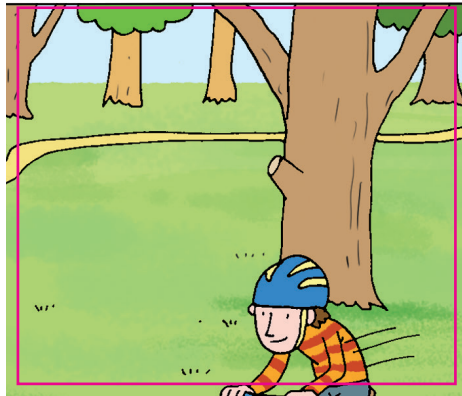
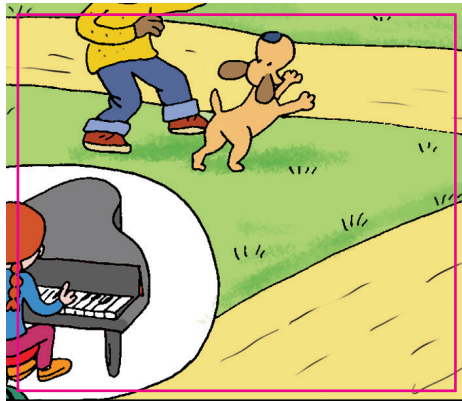

THE FINAL RACE Lesson 2 Task 2

Yes, he has.

I'm playing the piano.

She is flying.

A white T-shirt and blue jeans.

£15.

It's 5 o'clock.

I'm hungry.

Pink.

In the basket.

I'm 8.

It is sunny.

Jessica.

UNIT 2 Lesson 5 Task 2

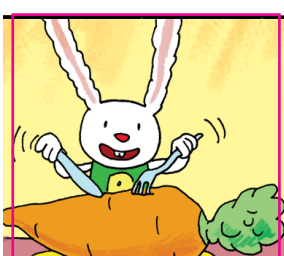
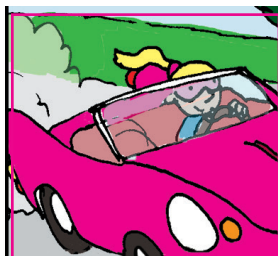
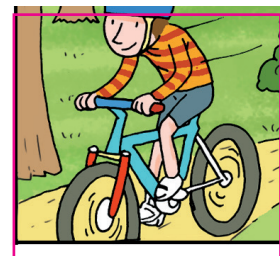
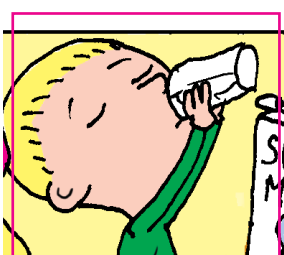

UNIT 4 Lesson 2 Task 1

seventeen	fifteen	twenty	twelve
six	nine	eight	one
	eleven	three	

UNIT 5 Lesson 3 Task 1

The baby jaguar	orange juice	Pixy	five o'clock
twelve o'clock	super milk	eight o'clock	eight o'clock
	jungle	desert	

UNIT 7 Lesson 4 Task 1



APPENDIX

